

THE BIG BOOK OF MISCHIEF 1.3 10-06-91 [REPLACES TBBOM12.ZIP/ TBBOM12.TXT]

BOX 438, 71 E. 32nd St. Chicago, IL 60616

Make all checks and money orders payable to: LASERSCRIBE, INC.

## Preface

By version 1.5 I hope to have .GIF files to replace the current character graphics, and to have removed all duplicate entries.

### Note from the Editor:

To make suggestions, corrections, or to submit new information, send mail to:  
to DAVID RICHARDS on the RIPCO BBS, or:  
cshawk\_pro38@iitvax.iit.edu  
cshawk\_pro38@iitvax.bitnet

Please refer to any items by section number or EXACT section heading.

### Note from the author:

Remember, the First Amendment is not a shield. Care must be taken to ensure that no law is broken when information is gained or divulged. I have read every word of this file, and swear that no article of this document is illegal in any way.

## REVISION HISTORY

- 1987-1989      Compilation of original file
- Early 1990      Original file lost in crash
- August 8, 1990   File reborn as The Compleat Terrorist Today, August 8th, 1990, at 1 AM, I found a copy of The Terrorist's Handbook on a BBS, and recombined it with some other G-files.
- March 31, 1991   In February, I had a major loss of data, but regained TCT from a local BBS. I did some cosmetic work and killed some redundancies, and renamed the file to TBBOM. Total file size is now about 172 printed pages. (You may wish to print this file out and bind it)
- April 12, 1991   File revised by Vlad Tepes on Ripco II. Some deletions and many valuable additions. I (The Editor) felt that the file should have version numbers, so, in light of the additions by Vlad Tepes, the first volume number is 1.1.
- July 29, 1991   Revisions and addenda by Vlad Tepes. A revision is a change in the information (The original text is immediately followed

by the new information) and an addendum refers to new information.

October 6, 1991 Vlad Tepes assumes the job of co-author/editor. A few necessary deletions are made, as well as minor cosmetic changes and additions.

begin "THE BIG BOOK OF MISCHIEF"

## 1.0 INTRODUCTION

Chaos Industries (CHAOS), is proud to present this revised edition of The Terrorist's Handbook. First and foremost, let it be stated that Chaos Industries assumes no responsibilities for any use of the information presented in this publication. The purpose of this is to show the many techniques and methods used by those people in this and other countries who employ terror as a means to achieve political and social goals. The techniques described here may be found in public libraries, and can often be carried out by a terrorist with minimal resources. The processes and techniques herein SHOULD NOT BE CARRIED OUT UNDER ANY CIRCUMSTANCES!! SERIOUS INJURY OR DEATH COULD RESULT FROM ATTEMPTING TO PERFORM ANY OF THE METHODS IN THIS PUBLICATION. ALTHOUGH ALL EFFORTS HAVE BEEN MADE TO INSURE ACCURACY THIS IS MERELY FOR READING ENJOYMENT, AND IS NOT INTENDED FOR ACTUAL USE!!

We feel that it is important that everyone has some idea of just how easy it is for a terrorist to perform acts of terror; that is the justification for the existence of this publication.

### 1.1 Table of Contents ÄÄÄÄÄÄÄÄÄÄÄÄÄÄÄÄÄÄ

- 2.0 ..... BUYING EXPLOSIVES AND PROPELLANTS
  - 2.01 ..... Black Powder
  - 2.02 ..... Pyrodex
  - 2.03 ..... Rocket Engine Powder
  - 2.04 ..... Rifle/Shotgun Powder
  - 2.05 ..... Flash Powder
  - 2.06 ..... Ammonium Nitrate
- 2.1 ..... ACQUIRING CHEMICALS
  - 2.11 ..... Techniques for Picking Locks
- 2.2 ..... LIST OF USEFUL HOUSEHOLD CHEMICALS AND AVAILABILITY
- 2.3 ..... PREPARATION OF CHEMICALS
  - 2.31 ..... Nitric Acid
  - 2.32 ..... Sulfuric Acid
  - 2.33 ..... Ammonium Nitrate
- 3.0 ..... EXPLOSIVE RECIPES
  - 3.01 ..... Explosive Theory
- 3.1 ..... IMPACT EXPLOSIVES
  - 3.11 ..... Ammonium Triiodide Crystals
  - 3.12 ..... Mercury Fulminate
  - 3.13 ..... Nitroglycerine

- 3.14 ..... Picrates
- 3.2 ..... LOW ORDER EXPLOSIVES
  - 3.21 ..... Black Powder
  - 3.22 ..... Nitrocellulose
  - 3.23 ..... Fuel + Oxidizer mixtures
  - 3.24 ..... Perchlorates
  - 3.25 ..... Flash Powder
- 3.3 ..... HIGH ORDER EXPLOSIVES
  - 3.31 ..... R.D.X. (Cyclonite)
  - 3.32 ..... Ammonium Nitrate
  - 3.33 ..... ANFOS
  - 3.34 ..... T.N.T.
  - 3.35 ..... Potassium Chlorate
  - 3.36 ..... Dynamite
  - 3.37 ..... Nitrostarch Explosives
  - 3.38 ..... Picric Acid
  - 3.39 ..... Ammonium Picrate (Explosive D)
  - 3.40 ..... Nitrogen Trichloride
  - 3.41 ..... Lead Azide
- 3.5 ..... OTHER "EXPLOSIVES"
  - 3.51 ..... Thermite
  - 3.52 ..... Molotov Cocktails
  - 3.53 ..... Chemical Fire Bottle
  - 3.54 ..... Bottled Gas Explosives
- 3.6 ..... Dry Ice
- 4.0 ..... USING EXPLOSIVES
  - 4.1 ..... SAFETY
    - 4.11 ..... How Not To Get Killed
    - 4.12 ..... Guidelines For Production
  - 4.2 ..... IGNITION DEVICES
    - 4.21 ..... Fuse Ignition
    - 4.22 ..... Impact Ignition
    - 4.23 ..... Electrical Ignition
    - 4.24 ..... Electro - Mechanical Ignition
      - 4.241 ..... Mercury Switches
      - 4.242 ..... Tripwire Switches
      - 4.243 ..... Radio Control Detonators
  - 4.3 ..... DELAYS
    - 4.31 ..... Fuse Delays
    - 4.32 ..... Timer Delays
    - 4.33 ..... Chemical Delays
- 4.4 ..... EXPLOSIVE CONTAINERS
  - 4.41 ..... Paper Containers
  - 4.42 ..... Metal Containers
  - 4.43 ..... Glass Containers
  - 4.44 ..... Plastic Containers
- 4.5 ..... ADVANCED USES FOR EXPLOSIVES
  - 4.51 ..... Shaped Charges
  - 4.52 ..... Tube Explosives
  - 4.53 ..... Atomized Particle Explosions
  - 4.54 ..... Lightbulb Bombs
  - 4.55 ..... Book Bombs
  - 4.56 ..... Phone Bombs
- 5.0 ..... SPECIAL AMMUNITION FOR PROJECTILE WEAPONS

5.1	.....	PROJECTILE WEAPONS (PRIMITIVE)
5.11	.....	Bow and Crossbow Ammunition
5.12	.....	Blowgun Ammunition
5.13	.....	Wrist Rocket and Slingshot Ammunition
5.2	.....	PROJECTILE WEAPONS (FIREARMS)
5.21	.....	Handgun Ammunition
5.22	.....	Shotguns
5.3	.....	PROJECTILE WEAPONS (COMPRESSED GAS)
5.31	.....	.177 Caliber B.B Gun Ammunition
5.32	.....	.22 Caliber Pellet Gun Ammunition
6.0	.....	ROCKETS AND CANNONS
6.1	.....	ROCKETS
6.11	.....	Basic Rocket-Bomb
6.12	.....	Long Range Rocket-Bomb
6.13	.....	Multiple Warhead Rocket-Bombs
6.2	.....	CANNONS
6.21	.....	Basic Pipe Cannon
6.22	.....	Rocket-Firing Cannon
6.23	.....	Reinforced Pipe Cannon
7.0	.....	PYROTECHNICA ERRATA
7.1	.....	Smoke Bombs
7.2	.....	Colored Flames
7.3	.....	Tear Gas
7.4	.....	Fireworks
7.41	.....	Firecrackers
7.42	.....	Skyrockets
7.43	.....	Roman Candles
8.0	.....	LISTS OF SUPPLIERS AND FURTHER INFORMATION
9.0	.....	CHECKLIST FOR RAIDS ON LABS
10.0	.....	USEFUL PYROCHEMISTRY
11.0	.....	ABOUT THE AUTHOR

## 2.0 BUYING EXPLOSIVES AND PROPELLANTS

Almost any city or town of reasonable size has a gun store and one or more pharmacies. These are two of the places that potential terrorists visit in order to purchase explosive material. All that one has to do is know something about the non- explosive uses of the materials. Black powder, for example, is used in blackpowder firearms. It comes in varying "grades", with each different grade being a slightly different size. The grade of black powder depends on what the calibre of the gun that it is used in; a fine grade of powder could burn too fast in the wrong caliber weapon. The rule is: the smaller the grade, the faster the burn rate of the powder.

### 2.01 BLACK POWDER

Black powder is generally available in three grades. As stated before, the smaller the grade, the faster the powder burns. Burn rate is extremely important in bombs. Since an explosion is a rapid increase of gas volume in a confined environment, to make an explosion, a quick-burning powder is desirable. The three common grades of black powder are listed below, along with the usual bore width (calibre) of what they are used in. Generally, the fastest burning

powder, the FFF grade is desirable. However, the other grades and uses are listed below:

GRADE	BORE WIDTH	EXAMPLE OF GUN
F	.50 or greater	model cannon; some rifles
FF	.36 - .50	large pistols; small rifles
FFF	.36 or smaller	pistols; derringers

The FFF grade is the fastest burning, because the smaller grade has more surface area or burning surface exposed to the flame front. The larger grades also have uses which will be discussed later. The price range of black powder, per pound, is about \$8.50 - \$9.00. The price is not affected by the grade, and so one saves oneself time and work if one buys the finer grade of powder. The major problems with black powder are that it can be ignited accidentally by static electricity, and that it has a tendency to absorb moisture from the air. To safely crush it, a one would use a plastic spoon and a wooden salad bowl. Taking a small pile at a time, he or she would apply pressure to the powder through the spoon and rub it in a series of strokes or circles, but not too hard. It is fine enough to use when it is about as fine as flour. The fineness, however, is dependant on what type of device one wishes to make; obviously, it would be impracticable to crush enough powder to fill a 1 foot by 4 inch radius pipe. Any adult can purchase black powder, since anyone can own black powder firearms in the United States.

## 2.02 PYRODEX

Pyrodex is a synthetic powder that is used like black powder. It comes in the same grades, but it is more expensive per pound. However, a one pound container of pyrodex contains more material by volume than a pound of black powder. It is much easier to crush to a very fine powder than black powder, and it is considerably safer and more reliable. This is because it will not be set off by static electricity, as black can be, and it is less inclined to absorb moisture. It costs about \$10.00 per pound. It can be crushed in the same manner as black powder, or it can be dissolved in boiling water and dried.

## 2.03 ROCKET ENGINE POWDER

One of the most exciting hobbies nowadays is model rocketry. Estes is the largest producer of model rocket kits and engines. Rocket engines are composed of a single large grain of propellant. This grain is surrounded by a fairly heavy cardboard tubing. One gets the propellant by slitting the tube length- wise, and unwrapping it like a paper towel roll. When this is done, the gray fire clay at either end of the propellant grain must be removed. This is usually done gently with a plastic or brass knife. The material is exceptionally hard, and must be crushed to be used. By gripping the grain in the widest setting on a set of pliers, and putting the grain and powder in a plastic bag, the powder will not break apart and shatter all over. This should be done to all the large chunks of powder, and then it should be crushed like black powder. Rocket engines come in various sizes, ranging from 1/4 A - 2T to the incredibly powerful D engines. The larger the engine, the

more expensive. D engines come in packages of three, and cost about \$5.00 per package. Rocket engines are perhaps the single most useful item sold in stores to a terrorist, since they can be used as is, or can be cannibalized for their explosive powder.

#### 2.04 RIFLE/SHOTGUN POWDER

Rifle powder and shotgun powder are really the same from a practical standpoint. They are both nitrocellulose based propellants. They will be referred to as gunpowder in all future references. Smokeless gunpowder is made by the action of concentrated nitric and sulfuric acid upon cotton or some other cellulose material. This material is then dissolved by solvents and then reformed in the desired grain size. When dealing with smokeless gunpowder, the grain size is not nearly as important as that of black powder. Both large and small grained smokeless powder burn fairly slowly compared to black powder when unconfined, but when it is confined, gunpowder burns both hotter and with more gaseous expansion, producing more pressure. Therefore, the grinding process that is often necessary for other propellants is not necessary for smokeless powder. Powder costs about \$9.00 per pound. In most states any citizen with a valid driver's license can buy it, since there are currently few restrictions on rifles or shotguns in the U.S. There are now ID checks in many states when purchasing powder at a retail outlet. Mail-orders aren't subject to such checks. Rifle powder and pyrodex may be purchased by mail order, but UPS charges will be high, due to DOT regulations on packaging.

#### 2.05 FLASH POWDER

Flash powder is a mixture of powdered aluminum metal and various oxidizers. It is extremely sensitive to heat or sparks, and should be treated with more care than black powder, with which it should NEVER be mixed. It is sold in small containers which must be mixed and shaken before use. It is very finely powdered, and is available in three speeds: fast, medium, and slow. The fast flash powder is the best for using in explosives or detonators.

It burns very rapidly, regardless of confinement or packing, with a hot white "flash", hence its name. It is fairly expensive, costing about \$11.00. It is sold in magic shops and theatre supply stores. Flash powder is often made with aluminum and/or magnesium. Zirconium metal is the main ingredient in flash BULBS, but is too expensive to be used in most flash powder mixtures.

#### 2.06 AMMONIUM NITRATE

Ammonium nitrate is a high explosive material that is often used as a commercial "safety explosive" It is very stable, and is difficult to ignite with a match. It will only light if the glowing, red-hot part of a match is touching it. It is also difficult to detonate; (the phenomenon of detonation will be explained later) it requires a large shockwave to cause it to go high explosive. Commercially, it is sometimes mixed with a small amount of nitroglycerine to increase its sensitivity. Ammonium nitrate is used in the "Cold-Paks" or "Instant Cold", available in most drug stores. The "Cold Paks" consist of a bag of water, surrounded by a second plastic bag containing the ammonium nitrate. To get the ammonium nitrate, simply cut off the top of the outside bag,

remove the plastic bag of water, and save the ammonium nitrate in a well sealed, airtight container, since it is rather hygroscopic, i.e. it tends to absorb water from the air. It is also the main ingredient in many fertilizers.

## 2.1 ACQUIRING CHEMICALS

The first section deals with getting chemicals legally. This section deals with "procuring" them. The best place to steal chemicals is a college. Many state schools have all of their chemicals out on the shelves in the labs, and more in their chemical stockrooms. Evening is the best time to enter lab buildings, as there are the least number of people in the buildings, and most of the labs will still be unlocked.

### 2.11 TECHNIQUES FOR PICKING LOCKS

If it becomes necessary to pick a lock to enter a lab, the world's most effective lockpick is dynamite, followed by a sledgehammer. There are unfortunately, problems with noise and excess structural damage with these methods. The next best thing, however, is a set of professional lockpicks.

These, unfortunately, are difficult to acquire. If the door to a lab is locked, but the deadbolt is not engaged, then there are other possibilities. The rule here is: if one can see the latch, one can open the door. There are several devices which facilitate freeing the latch from its hole in the wall. Dental tools, stiff wire ( 20 gauge ), specially bent aluminum from cans, thin pocket knives, and credit cards are the tools of the trade. The way that all these tools and devices are used is similar: pull, push, or otherwise move the latch out of its recess in the wall, thus allowing the door to open. This is done by sliding whatever tool that you are using behind the latch, and forcing the latch back into the door.

Most modern doorknob locks have two fingers. The larger finger holds the door closed while the second (smaller) finger only prevents the first finger from being pressed in when it (the second finger) is pressed in by the catchplate of the door. If you can separate the catch plate and the lock sufficiently far, the second finger will slip out enough to permit the first finger to be slipped.

(Ill. 2.11)

Small second finger -> (| } <--- The large (first) finger

Some methods for getting through locked doors are:

- 1) Another method of forced entry is to use an automobile jack to force the frame around the door out of shape, freeing the latch or exposing it to the above methods. This is possible because most door frames are designed with a slight amount of "give". Simply put the jack into position horizontally across the frame in the vicinity of the latch, and jack it out. If the frame is wood it may be possible to remove the jack after

shutting the door, which will relock the door and leave few signs of forced entry. This technique will not work in concrete block buildings, and it's difficult to justify an auto jack to the security guards.

- 2) use a screwdriver or two to pry the lock and door apart. While holding them apart, try to slip the lock. Screwdrivers, while not entirely innocent, are much more subtle than auto jacks, and much faster if they work. If you're into unsubtle, I suppose a crowbar would work too, but then why bother to slip the lock at all?
- 3) Find a set of double doors. They are particularly easy to pry apart far enough to slip.
- 4) If the lock is occasionally accessible to you while open, "adjust" or replace the catchplate to make it operate more suitably (i.e., work so that it lets \*both\* fingers out, so that it can always be slipped). If you want, disassembling the lock and removing some of the pins can make it much easier to pick.
- 5) If, for some odd reason, the hinges are on your side (i.e., the door opens outward), remove the hinge pins (provided they aren't stopped with welded tabs). Unfortunately, this too lacks subtlety, in spite of its effectiveness.
- 6) If the door cannot be slipped and you will want to get through regularly, break the mechanism. Use of sufficient force to make the first finger retreat while the second finger is retreated will break some locks (e.g., Best locks) in such a way that they may thereafter be slipped trivially, yet otherwise work in all normal ways. Use of a hammer and/or screwdriver is recommended. Some care should be used not to damage the door jamb when attempting this on closed and locked doors, so as not to attract the attention of the users/owners/locksmith/police/....
- 7) Look around in desks. People very often leave keys to sensitive things in them or other obvious places. Especially keys to shared critical resources, like supply rooms, that are typically key-limited but that everyone needs access to. Take measurements with a micrometer, or make a tracing (lay key under paper and scribble on top), or be dull and make a wax impression. Get blanks for the key type (can be very difficult for better locks; I won't go into methods, other than to say that if you can get other keys made from the same blank, you can often work wonders with a little ingenuity) and use a file to reproduce the key. Using a micrometer works best: keys made from mic measurements are more likely to work consistently than keys made by any other method. If you use tracings, it is likely to take many tries before you obtain a key that works reliably. Also, if you can 'borrow' the cylinder and disassemble it, pin levels can be obtained and keys constructed.
- 8) Simple locks, like desks, can be picked fairly easily. Many desks have simple three or four pin locks of only a few levels, and can be consistently picked by a patient person in a few minutes. A small screwdriver and a paper clip will work wonders in practiced hands. Apply a slight torque to the lock in the direction of opening with the screwdriver. Then 'rake' the pins with the unfolded paper clip. With practice, you'll apply enough pressure with the screwdriver that the pins will align properly (they'll catch on the cylinder somewhere between the top and bottom of their normal travel), and once they're all lined up, additional pressure on the screwdriver will then open the lock. This, in conjunction with (7) can be very effective. This works better with older or sloppily machined locks that have a fair amount of play in the cylinder. Even older quality locks can be picked in this manner, if

their cylinders have been worn enough to give enough play to allow pins to catch reliably. Even with a well worn quality lock, though, it generally takes a \*lot\* of patience.

- 9) Custodial services often open up everything in sight and then take breaks. Make the most of your opportunities.
- 10) No matter what you're doing, look like you belong there. Nothing makes anyone more suspicious than someone skulking about, obviously trying to look inconspicuous. If there are several of you, have some innocuous and normal seeming warning method ("Hey, dummy! What time is it?") so that they can get anything suspicious put away. Don't travel in large groups at 3 AM. Remember, more than one car thief has managed to enlist a cop's aid in breaking into a car. Remember this. Security people usually \*like\* to help people. Don't make them suspicious or annoy them. If you do run into security people, try to make sure that there won't be any theft or break-ins reported there the next day...
- 11) Consider the possibilities of master keys. Often, every lock in a building or department will have a common master (building entrance keys are a common exception). Take apart some locks from different places that should have common masters, measure the different pin lengths in each, and find lengths in common. Experiment. Then get into those places you're \*really\* curious about.
- 12) Control keys are fun, too. These keys allow the user to remove the lock's core, and are generally masters. (A pair of needle nose pliers or similar tool can then be used to open the lock, if desired.)

### 2.11.1 SLIPPING A LOCK

The best material we've found for slips so far is soft sheet copper. It is quite flexible, so it can be worked into jambs easily, and can be pre-bent as needed. In the plane of the sheet, however, it is fairly strong, and pulls nicely. Of course, if they're flexible enough, credit cards, student IDs, etc., work just fine on locks that have been made slippable if the door jamb is wide enough. Wonderfully subtle, quick, and delightfully effective. Don't leave home without one.

(Ill. 2.11.1 #1)

The sheet should then be folded to produce an L,J,or U shaped device that looks like this:

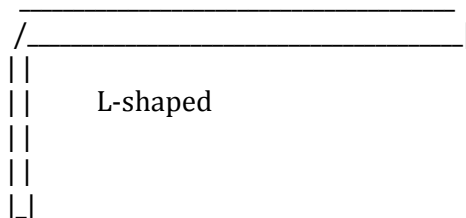

(Ill. 2.11.1 #2)

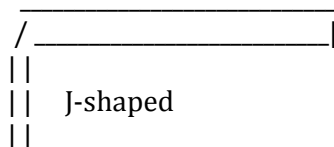

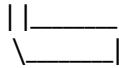

(Ill. 2.11.1 #3)

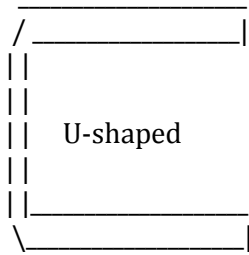

We hasten to add here that many or most colleges and universities have very strict policies about unauthorized possession of keys. At most, it is at least grounds for expulsion, even without filing criminal charges. Don't get caught with keys!!! The homemade ones are particularly obvious, as they don't have the usual stamps and marks that the locksmiths put on to name and number the keys.]

we should also point out that if you make a nuisance of yourself, there are various nasty things that can be done to catch you and/or slow you down. For instance, by putting special pin mechanisms in, locks can be made to trap any key used to open them. If you lose one this way, what can I say? At least don't leave fingerprints on it. Or make sure they're someone else's. Too much mischief can also tempt the powers that be to rekey.

### 2.11.2 OPENING MASTER "WARDED" LOCKS (by Vlad Tepes)

These are the lock with the keys that look like this:

(Ill. 2.11.2 #1)

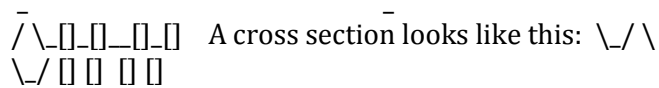

Just file the key down so it looks like this:

(Ill. 2.11.2 #2)

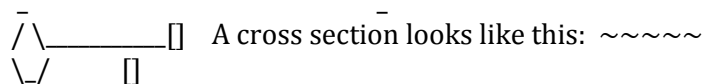

Now you can bypass the wards... sometimes you have to pull the key up and down, turning as you pass each block, to find the internal lever that will release the latch. It's possible that some of the newer locks have more than one lever, which makes the process much more difficult.

## 2.2 LIST OF USEFUL HOUSEHOLD CHEMICALS AND THEIR AVAILABILITY

Anyone can get many chemicals from hardware stores, supermarkets, and drug stores to get the materials to make explosives or other dangerous compounds. A would-be terrorist would merely need a station wagon and some money to acquire many of the chemicals named here.

Chemical	Used In	Available at
alcohol, ethyl *	alcoholic beverages solvents (95% min. for both)	liquor stores hardware stores
ammonia +	CLEAR household ammonia	supermarkets/7-eleven
ammonium nitrate	instant-cold paks, fertilizers	drug stores, medical supply stores
nitrous oxide	pressurizing whip cream poppers (like CO2 ctgs.)	party supply stores Head shops (The Alley at Belmont/Clark, Chgo)
magnesium	firestarters	surplus/camping stores
lecithin	vitamins	pharmacies/drug stores
mineral oil	cooking, laxative	supermarket/drug stores
mercury	mercury thermometers	supermarkets, hardware stores
sulfuric acid	uncharged car batteries	automotive stores
glycerine		pharmacies/drug stores
sulfur	gardening	gardening/hardware store
charcoal	charcoal grills	supermarkets gardening stores
sodium nitrate	fertilizer	gardening store
cellulose (cotton)	first aid	drug medical supply stores
strontium nitrate	road flares	surplus/auto stores,
fuel oil	kerosene stoves	surplus/camping stores,
bottled gas	propane stoves	surplus/camping stores,
potassium permanganate	water purification	purification plants
hexamine or methenamine	hexamine stoves (camping)	surplus/camping stores



begins to come out of the end of the retort. The liquid that forms is nitric acid. Heat until the precipitate in the bottom of the retort is almost dry, or until no more nitric acid is forming. CAUTION: If the acid is heated too strongly, the nitric acid will decompose as soon as it is formed. This can result in the production of highly flammable and toxic gasses that may explode. It is a good idea to set the above apparatus up, and then get away from it.

Potassium nitrate could also be obtained from store-bought black powder, simply by dissolving black powder in boiling water and filtering out the sulfur and charcoal. To obtain 68 g of potassium nitrate, it would be necessary to dissolve about 90 g of black powder in about one litre of boiling water. Filter the dissolved solution through filter paper in a funnel into a jar until the liquid that pours through is clear. The charcoal and sulfur in black powder are insoluble in water, and so when the solution of water is allowed to evaporate, potassium nitrate will be left in the jar.

### 2.32 SULFURIC ACID

Sulfuric acid is far too difficult to make outside of a laboratory or industrial plant. However, it is readily available in an uncharged car battery. A person wishing to make sulfuric acid would simply remove the top of a car battery and pour the acid into a glass container. There would probably be pieces of lead from the battery in the acid which would have to be removed, either by boiling or filtration. The concentration of the sulfuric acid can also be increased by boiling it; very pure sulfuric acid pours slightly faster than clean motor oil.

### 2.33 AMMONIUM NITRATE

Ammonium nitrate is a very powerful but insensitive high-order explosive. It could be made very easily by pouring nitric acid into a large flask in an ice bath. Then, by simply pouring household ammonia into the flask and running away, ammonium nitrate would be formed. After the materials have stopped reacting, one would simply have to leave the solution in a warm place until all of the water and any unneutralized ammonia or acid have evaporated. There would be a fine powder formed, which would be ammonium nitrate. It must be kept in an airtight container, because of its tendency to pick up water from the air. The crystals formed in the above process would have to be heated VERY gently to drive off the remaining water.

## 3.0 EXPLOSIVE RECIPES

Once again, persons reading this material MUST NEVER ATTEMPT TO PRODUCE ANY OF THE EXPLOSIVES DESCRIBED HEREIN. IT IS ILLEGAL AND EXTREMELY DANGEROUS TO ATTEMPT TO DO SO. LOSS OF LIFE AND/OR LIMB COULD EASILY OCCUR AS A RESULT OF ATTEMPTING TO PRODUCE EXPLOSIVE MATERIALS.

These recipes are theoretically correct, meaning that an individual could conceivably produce the materials described. The methods here are usually

scaled-down industrial procedures.

### 3.01 EXPLOSIVE THEORY

An explosive is any material that, when ignited by heat or shock, undergoes rapid decomposition or oxidation. This process releases energy that is stored in the material in the form of heat and light, or by breaking down into gaseous compounds that occupy a much larger volume than the original piece of material. Because this expansion is very rapid, large volumes of air are displaced by the expanding gasses. This expansion occurs at a speed greater than the speed of sound, and so a sonic boom occurs. This explains the mechanics behind an explosion. Explosives occur in several forms: high-order explosives which detonate, low order explosives, which burn, and primers, which may do both.

High order explosives detonate. A detonation occurs only in a high order explosive. Detonations are usually incurred by a shockwave that passes through a block of the high explosive material. The shockwave breaks apart the molecular bonds between the atoms of the substance, at a rate approximately equal to the speed of sound traveling through that material. In a high explosive, the fuel and oxidizer are chemically bonded, and the shockwave breaks apart these bonds, and re-combines the two materials to produce mostly gasses. T.N.T., ammonium nitrate, and R.D.X. are examples of high order explosives.

Low order explosives do not detonate; they burn, or undergo oxidation. When heated, the fuel(s) and oxidizer(s) combine to produce heat, light, and gaseous products. Some low order materials burn at about the same speed under pressure as they do in the open, such as blackpowder. Others, such as gunpowder, which is correctly called nitrocellulose, burn much faster and hotter when they are in a confined space, such as the barrel of a firearm; they usually burn much slower than blackpowder when they are ignited in unpressurized conditions. Black powder, nitrocellulose, and flash powder are good examples of low order explosives.

Primers are peculiarities to the explosive field. Some of them, such as mercury fulminate, will function as a low or high order explosive. They are usually more sensitive to friction, heat, or shock, than the high or low explosives. Most primers perform like a high order explosive, except that they are much more sensitive. Still others merely burn, but when they are confined, they burn at a great rate and with a large expansion of gasses and a shockwave. Primers are usually used in a small amount to initiate, or cause to decompose, a high order explosive, as in an artillery shell. But, they are also frequently used to ignite a low order explosive; the gunpowder in a bullet is ignited by the detonation of its primer.

### 3.1 IMPACT EXPLOSIVES

Impact explosives are often used as primers. Of the ones discussed here, only mercury fulminate and nitroglycerine are real explosives; Ammonium triiodide crystals decompose upon impact, but they release little heat and no light. Impact explosives are always treated with the greatest care, and even the stupidest anarchist never stores them near any high or low explosives.

### 3.11 AMMONIUM TRIIODIDE CRYSTALS

Ammonium triiodide crystals are foul-smelling purple colored crystals that decompose under the slightest amount of heat, friction, or shock, if they are made with the purest ammonia (ammonium hydroxide) and iodine. Such crystals are said to detonate when a fly lands on them, or when an ant walks across them. Household ammonia, however, has enough impurities, such as soaps and abrasive agents, so that the crystals will detonate when thrown, crushed, or heated. Ammonia, when bought in stores comes in a variety of forms. The pine and cloudy ammonias should not be bought; only the clear ammonia should be used to make ammonium triiodide crystals. Upon detonation, a loud report is heard, and a cloud of purple iodine gas appears about the detonation site. Whatever the unfortunate surface that the crystal was detonated upon will usually be ruined, as some of the iodine in the crystal is thrown about in a solid form, and iodine is corrosive. It leaves nasty, ugly, permanent brownish-purple stains on whatever it contacts. Iodine gas is also bad news, since it can damage lungs, and it settles to the ground and stains things there also. Touching iodine leaves brown stains on the skin that last for about a week, unless they are immediately and vigorously washed off. While such a compound would have little use to a serious terrorist, a vandal could utilize them in damaging property. Or, a terrorist could throw several of them into a crowd as a distraction, an action which would possibly injure a few people, but frighten almost anyone, since a small crystal that may not be seen when thrown produces a rather loud explosion.

Ammonium triiodide crystals could be produced in the following manner:

Materials	Equipment
iodine crystals	funnel and filter paper
clear ammonia (ammonium hydroxide, for the suicidal)	paper towels two throw-away glass jars

- 1) Place about two teaspoons of iodine into one of the glass jars. The jars must both be throw away because they will never be clean again.
- 2) Add enough ammonia to completely cover the iodine.
- 3) Place the funnel into the other jar, and put the filter paper in the funnel. The technique for putting filter paper in a funnel is taught in every basic chemistry lab class: fold the circular paper in half, so that a semi-circle is formed. Then, fold it in half again to form a triangle with one curved side. Pull one thickness of paper out to form a cone, and place the cone into the funnel.
- 4) After allowing the iodine to soak in the ammonia for a while, pour the solution into the paper in the funnel through the filter paper.
- 5) While the solution is being filtered, put more ammonia into the first jar to wash any remaining crystals into the funnel as soon as it drains.

- 6) Collect all the purplish crystals without touching the brown filter paper, and place them on the paper towels to dry for about an hour. Make sure that they are not too close to any lights or other sources of heat, as they could well detonate. While they are still wet, divide the wet material into eight pieces of about the same size.
- 7) After they dry, gently place the crystals onto a one square inch piece of duct tape. Cover it with a similar piece, and gently press the duct tape together around the crystal, making sure not to press the crystal itself. Finally, cut away most of the excess duct tape with a pair of scissors, and store the crystals in a cool dry safe place. They have a shelf life of about a week, and they should be stored in individual containers that can be thrown away, since they have a tendency to slowly decompose, a process which gives off iodine vapors, which will stain whatever they settle on. One possible way to increase their shelf life is to store them in airtight containers. To use them, simply throw them against any surface or place them where they will be stepped on or crushed.

### 3.12 MERCURY FULMINATE

Mercury fulminate is perhaps one of the oldest known initiating compounds. It can be detonated by either heat or shock, which would make it of infinite value to a terrorist. Even the action of dropping a crystal of the fulminate causes it to explode. A person making this material would probably use the following procedure:

MATERIALS	EQUIPMENT
5 g mercury	glass stirring rod
35 ml concentrated nitric acid	100 ml beaker (2)
ethyl alcohol (30 ml)	adjustable heat source
distilled water	blue litmus paper
	funnel and filter paper

Solvent alcohol must be at least 95% ethyl alcohol if it is used to make mercury fulminate. Methyl alcohol may prevent mercury fulminate from forming.

Mercury thermometers are becoming a rarity, unfortunately. They may be hard to find in most stores as they have been superseded by alcohol and other less toxic fillings. Mercury is also used in mercury switches, which are available at electronics stores. Mercury is a hazardous substance, and should be kept in the thermometer or mercury switch until used. It gives off mercury vapors which will cause brain damage if inhaled. For this reason, it is a good idea not to spill mercury, and to always use it outdoors. Also, do not get it in an open cut; rubber gloves will help prevent this.

- 1) In one beaker, mix 5 g of mercury with 35 ml of concentrated nitric acid, using the glass rod.

- 2) Slowly heat the mixture until the mercury is dissolved, which is when the solution turns green and boils.
- 3) Place 30 ml of ethyl alcohol into the second beaker, and slowly and carefully add all of the contents of the first beaker to it. Red and/or brown fumes should appear. These fumes are toxic and flammable.
- 4) After thirty to forty minutes, the fumes should turn white, indicating that the reaction is near completion. After ten more minutes, add 30 ml of the distilled water to the solution.
- 5) Carefully filter out the crystals of mercury fulminate from the liquid solution. Dispose of the solution in a safe place, as it is corrosive and toxic.
- 6) Wash the crystals several times in distilled water to remove as much excess acid as possible. Test the crystals with the litmus paper until they are neutral. This will be when the litmus paper stays blue when it touches the wet crystals
- 7) Allow the crystals to dry, and store them in a safe place, far away from any explosive or flammable material.

This procedure can also be done by volume, if the available mercury cannot be weighed. Simply use 10 volumes of nitric acid and 10 volumes of ethanol to every one volume of mercury.

### 3.13 NITROGLYCERINE

Nitroglycerine is one of the most sensitive explosives, if it is not the most sensitive. Although it is possible to make it safely, it is difficult. Many a young anarchist has been killed or seriously injured while trying to make the stuff. When Nobel's factories make it, many people were killed by the all-to-frequent factory explosions. Usually, as soon as it is made, it is converted into a safer substance, such as dynamite. An idiot who attempts to make nitroglycerine would use the following procedure:

MATERIAL	EQUIPMENT
distilled water	eye-dropper
table salt	100 ml beaker
sodium bicarbonate	200-300 ml beakers (2)
concentrated nitric acid (13 ml)	ice bath container ( a plastic bucket serves well )
concentrated sulfuric acid (39 ml)	centigrade thermometer
glycerine	blue litmus paper

- 1) Place 150 ml of distilled water into one of the 200-300 ml beakers.
- 2) In the other 200-300 ml beaker, place 150 ml of distilled water and about a spoonful of sodium bicarbonate, and stir them until the sodium bicarbonate dissolves. Do not put so much sodium bicarbonate in the water so that some remains undissolved.
- 3) Create an ice bath by half filling the ice bath container with ice, and adding table salt. This will cause the ice to melt, lowering the overall temperature.
- 4) Place the 100 ml beaker into the ice bath, and pour the 13 ml of concentrated nitric acid into the 100 ml beaker. Be sure that the beaker will not spill into the ice bath, and that the ice bath will not overflow into the beaker when more materials are added to it. Be sure to have a large enough ice bath container to add more ice. Bring the temperature of the acid down to about 20 degrees centigrade or less.
- 5) When the nitric acid is as cold as stated above, slowly and carefully add the 39 ml of concentrated sulfuric acid to the nitric acid. Mix the two acids together, and cool the mixed acids to 10 degrees centigrade. It is a good idea to start another ice bath to do this.
- 6) With the eyedropper, slowly put the glycerine into the mixed acids, one drop at a time. Hold the thermometer along the top of the mixture where the mixed acids and glycerine meet.

DO NOT ALLOW THE TEMPERATURE TO GET ABOVE 30 DEGREES CENTIGRADE; IF THE TEMPERATURE RISES ABOVE THIS TEMPERATURE, WATCH OUT !!

The glycerine will start to nitrate immediately, and the temperature will immediately begin to rise. Add glycerine until there is a thin layer of glycerine on top of the mixed acids. It is always safest to make any explosive in small quantities.

- 7) Stir the mixed acids and glycerine for the first ten minutes of nitration, adding ice and salt to the ice bath to keep the temperature of the solution in the 100 ml beaker well below 30 degrees centigrade. Usually, the nitroglycerine will form on the top of the mixed acid solution, and the concentrated sulfuric acid will absorb the water produced by the reaction.
- 8) When the reaction is over, and when the nitroglycerine is well below 30 degrees centigrade, slowly and carefully pour the solution of nitroglycerine and mixed acid into the distilled water in the beaker in step 1. The nitroglycerine should settle to the bottom of the beaker, and the water-acid solution on top can be poured off and disposed of. Drain as much of the acid- water solution as possible without disturbing the nitroglycerine.
- 9) Carefully remove the nitroglycerine with a clean eye-dropper, and place it into the beaker in step 2. The sodium bicarbonate solution will eliminate much of the acid, which will make the nitroglycerine more stable, and less

likely to explode for no reason, which it can do. Test the nitroglycerine with the litmus paper until the litmus stays blue. Repeat this step if necessary, and use new sodium bicarbonate solutions as in step 2.

10) When the nitroglycerine is as acid-free as possible, store it in a clean container in a safe place. The best place to store nitroglycerine is far away from anything living, or from anything of any value. Nitroglycerine can explode for no apparent reason, even if it is stored in a secure cool place.

### 3.14 PICRATES

Although the procedure for the production of picric acid, or trinitrophenol has not yet been given, its salts are described first, since they are extremely sensitive, and detonate on impact. By mixing picric acid with metal hydroxides, such as sodium or potassium hydroxide, and evaporating the water, metal picrates can be formed. Simply obtain picric acid, or produce it, and mix it with a solution of (preferably) potassium hydroxide, of a mid range molarity. (about 6-9 M) This material, potassium picrate, is impact-sensitive, and can be used as an initiator for any type of high explosive.

### 3.2 LOW-ORDER EXPLOSIVES

There are many low-order explosives that can be purchased in gun stores and used in explosive devices. However, it is possible that a wise store owner would not sell these substances to a suspicious-looking individual. Such an individual would then be forced to resort to making his own low-order explosives.

#### 3.21 BLACK POWDER

First made by the Chinese for use in fireworks, black powder was first used in weapons and explosives in the 12th century. It is very simple to make, but it is not very powerful or safe. Only about 50% of black powder is converted to hot gasses when it is burned; the other half is mostly very fine burned particles. Black powder has one major problem: it can be ignited by static electricity. This is very bad, and it means that the material must be made with wooden or clay tools. Anyway, a misguided individual could manufacture black powder at home with the following procedure:

MATERIALS	EQUIPMENT
potassium nitrate (75 g)	clay grinding bowl and clay grinder
or	or
sodium nitrate (75 g)	wooden salad bowl and wooden spoon
sulfur (10 g)	plastic bags (3)

charcoal (15 g)      300-500 ml beaker (1)  
distilled water      coffee pot or heat source

- 1) Place a small amount of the potassium or sodium nitrate in the grinding bowl and grind it to a very fine powder. Do this to all of the potassium or sodium nitrate, and store the ground powder in one of the plastic bags.
- 2) Do the same thing to the sulfur and charcoal, storing each chemical in a separate plastic bag.
- 3) Place all of the finely ground potassium or sodium nitrate in the beaker, and add just enough boiling water to the chemical to get it all wet.
- 4) Add the contents of the other plastic bags to the wet potassium or sodium nitrate, and mix them well for several minutes. Do this until there is no more visible sulfur or charcoal, or until the mixture is universally black.
- 5) On a warm sunny day, put the beaker outside in the direct sunlight. Sunlight is really the best way to dry black powder, since it is never too hot, but it is hot enough to evaporate the water.
- 6) Scrape the black powder out of the beaker, and store it in a safe container. Plastic is really the safest container, followed by paper. Never store black powder in a plastic bag, since plastic bags are prone to generate static electricity.

### 3.22 NITROCELLULOSE

Nitrocellulose is usually called "gunpowder" or "guncotton". It is more stable than black powder, and it produces a much greater volume of hot gas. It also burns much faster than black powder when it is in a confined space. Finally, nitrocellulose is fairly easy to make, as outlined by the following procedure:

MATERIALS	EQUIPMENT
ÄÄÄÄÄÄÄÄÄÄ	ÄÄÄÄÄÄÄÄÄÄ
cotton (cellulose)	two (2) 200-300 ml beakers
concentrated nitric acid	funnel and filter paper
	blue litmus paper
concentrated sulfuric acid	
distilled water	

- 1) Pour 10 cc of concentrated sulfuric acid into the beaker. Add to this 10

cc of concentrated nitric acid.

- 2) Immediately add 0.5 gm of cotton, and allow it to soak for exactly 3 minutes.
- 3) Remove the nitrocotton, and transfer it to a beaker of distilled water to wash it in.
- 4) Allow the material to dry, and then re-wash it.
- 5) After the cotton is neutral when tested with litmus paper, it is ready to be dried and stored.

### 3.22.1 PRODUCING CELLULOSE NITRATE (From Andrew at CMU)

I used to make nitrocellulose, though. It was not guncotton grade, because I didn't have oleum ( $\text{H}_2\text{SO}_4$  with dissolved  $\text{SO}_3$ ); nevertheless it worked. At first I got my  $\text{H}_2\text{SO}_4$  from a little shop in downtown Philadelphia, which sold soda-acid fire extinguisher refills. Not only was the acid concentrated, cheap and plentiful, it came with enough carbonate to clean up. I'd add  $\text{KNO}_3$  and a little water (OK, I'd add the acid to the water - but there was so little water, what was added to what made little difference. It spattered concentrated  $\text{H}_2\text{SO}_4$  either way). Later on, when I could purchase the acids, I believe I used 3 parts  $\text{H}_2\text{SO}_4$  to 1 part  $\text{HNO}_3$ . For cotton, I'd use cotton wool or cotton cloth.

Runaway nitration was commonplace, but it is usually not so disastrous with nitrocellulose as it is with nitroglycerine. For some reason, I tried washing the cotton cloth in a solution of lye, and rinsing it well in distilled water. I let the cloth dry and then nitrated it. (Did I read this somewhere?) When that product was nitrated, I never got a runaway reaction. BTW, water quenched the runaway reaction of cellulose.

The product was washed thoroughly and allowed to dry. It dissolved (or turned into mush) in acetone. It dissolved in alcohol/ether.

### WARNINGS

All usual warnings regarding strong acids apply.  $\text{H}_2\text{SO}_4$  likes to spatter. When it falls on the skin, it destroys tissue - often painfully. It dissolves all manner of clothing. Nitric also destroys skin, turning it bright yellow in the process. Nitric is an oxidant - it can start fires. Both agents will happily blind you if you get them in your eyes. Other warnings also apply. Not for the novice.

Nitrocellulose decomposes very slowly on storage if it isn't stabilized. The decomposition is auto-catalyzing, and can result in spontaneous explosion if the material is kept confined over time. The process is much faster if the material is not washed well enough. Nitrocellulose powders contain stabilizers such as diphenyl amine or ethyl centralite. **DO NOT ALLOW THESE TO COME INTO CONTACT WITH NITRIC ACID!!!!** A small amount of either substance will capture the small amounts of nitrogen oxides that result from decomposition. They therefore inhibit the autocatalysis. NC eventually will decompose in any case.

Again, this is inherently dangerous and illegal in certain areas. I got away with it. You may kill yourself and others if you try it.

3.22.2 Commercially produced Nitrocellulose is stabilized by:

1. Spinning it in a large centrifuge to remove the remaining acid, which is recycled.
2. Immersion in a large quantity of fresh water.
3. Boiling it in acidulated water and washing it thoroughly with fresh water.

If the NC is to be used as smokeless powder it is boiled in a soda solution, then rinsed in fresh water.

The purer the acid used (lower water content) the more complete the nitration will be, and the more powerful the nitrocellulose produced.

There are actually three forms of cellulose nitrate, only one of which is useful for pyrotechnic purposes. The mononitrate and dinitrate are not explosive, and are produced by incomplete nitration. If nitration is allowed to proceed to complete the explosive trinitrate is formed.

(Ill. 3.22.2)

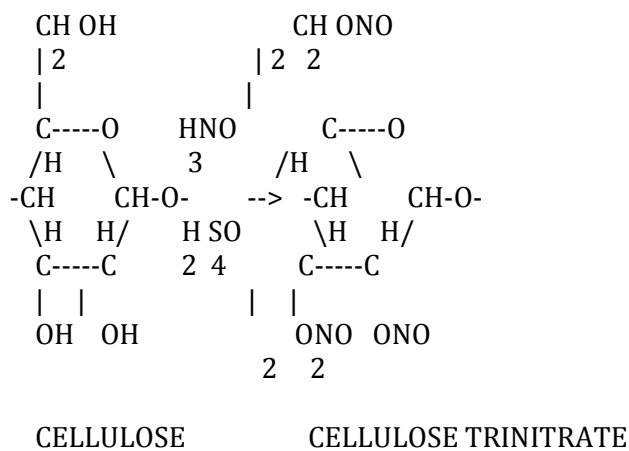

### 3.23 FUEL-OXODIZER MIXTURES

There are nearly an infinite number of fuel-oxidizer mixtures that can be produced by a misguided individual in his own home. Some are very effective and dangerous, while others are safer and less effective. A list of working fuel-oxidizer mixtures will be presented, but the exact measurements of each compound are debatable for maximum effectiveness. A rough estimate will be given of the percentages of each fuel and oxidizer:

oxidizer, % by weight	fuel, % by weight	speed #	notes
potassium chlorate 67%	sulfur 33%	5	friction/impact

sensitive; unstable

potassium chlorate 50%    sugar 35%    5    fairly slow burning;  
charcoal 15%    unstable

potassium chlorate 50%    sulfur 25%    8    extremely  
magnesium or    unstable!  
aluminum dust 25%

potassium chlorate 67%    magnesium or    8    unstable  
aluminum dust 33%

sodium nitrate 65%    magnesium dust 30%    ?    unpredictable  
sulfur 5%    burn rate

potassium permanganate 60%    glycerine 40%    4    delay before  
ignition depends  
WARNING: IGNITES SPONTANEOUSLY WITH GLYCERINE!!!    upon grain size

potassium permanganate 67%    sulfur 33%    5    unstable

potassium permanganate 60%    sulfur 20%    5    unstable  
magnesium or  
aluminum dust 20%

potassium permanganate 50%    sugar 50%    3    ?

potassium nitrate 75%    charcoal 15%    7    this is  
sulfur 10%    black powder!

potassium nitrate 60%    powdered iron    1    burns very hot  
or magnesium 40%

Oxidizer, % by weight    fuel, % by weight    speed #    notes

=====

potassium chlorate 75%    phosphorus    8    used to make strike-  
sesquisulfide 25%    anywhere matches

ammonium perchlorate 70%    aluminum dust 30%    6    solid fuel for  
and small amount of    space shuttle  
iron oxide

potassium perchlorate 67%    magnesium or    10    flash powder  
(sodium perchlorate)    aluminum dust 33%

potassium perchlorate 60%    magnesium or    8    alternate  
(sodium perchlorate)    aluminum dust 20%    flash powder  
sulfur 20%

barium nitrate 30%    aluminum dust 30%    9    alternate  
potassium perchlorate 30%    flash powder



back and forth.

(4) Do not store flash compositions, especially any containing Mg.

(5) Make very small quantities at first, so you can appreciate the power of such mixtures.

KNO<sub>3</sub> 50% (by weight)  
Mg 50%

It is very important to have the KNO<sub>3</sub> very dry, if evolution of ammonia is observed then the KNO<sub>3</sub> has water in it. Very pure and dry KNO<sub>3</sub> is needed.

KClO<sub>3</sub> with Mg or Al metal powders works very well. Many hands, faces and lives have been lost with such compositions.

KMnO<sub>4</sub> with Mg or Al is also an extremely powerful flash composition.

KClO<sub>4</sub> with Al is generally found in commercial fireworks, this does not mean that it is safe, it is a little safer than KClO<sub>3</sub> above.

K<sub>2</sub>Cr<sub>2</sub>O<sub>7</sub> can also be used as an oxidizer for flash powder.

The finer the oxidizer and the finer the metal powder the more powerful the explosive. This of course will also increase the sensitivity of the flash powder.

For a quick flash small quantities can be burnt in the open. Larger quantities (50g or more) ignited in the open can detonate, they do not need a container to do so.

NOTE: Flash powder in any container will detonate.

Balanced equations of some oxidizer/metal reactions. Only major products are considered. Excess metal powders are generally used. This excess burns with atmospheric oxygen.

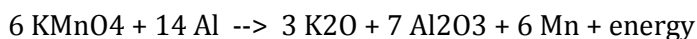
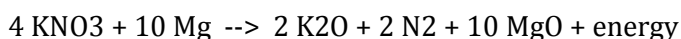

Make Black Powder first if you have never worked with pyrotechnic materials, then think about this stuff.

Dr. Van Tiel- Ph.D. Chemistry

Potassium perchlorate is a lot safer than sodium/potassium chlorate.

### 3.3 HIGH-ORDER EXPLOSIVES

High order explosives can be made in the home without too much difficulty. The main problem is acquiring the nitric acid to produce the high explosive. Most high explosives detonate because their molecular structure is made up of some fuel and usually three or more NO<sub>2</sub> ( nitrogen dioxide ) molecules. T.N.T., or Tri-Nitro-Toluene is an excellent example of such a material. When a shock wave passes through an molecule of T.N.T., the nitrogen dioxide bond is broken, and the oxygen combines with the fuel, all in a matter of microseconds. This accounts for the great power of nitrogen-based explosives. Remembering that these procedures are NEVER TO BE CARRIED OUT, several methods of manufacturing high-order explosives in the home are listed.

### 3.31 R.D.X.

R.D.X., also called cyclonite, or composition C-1 (when mixed with plasticisers) is one of the most valuable of all military explosives. This is because it has more than 150% of the power of T.N.T., and is much easier to detonate. It should not be used alone, since it can be set off by a not-too severe shock. It is less sensitive than mercury fulminate, or nitroglycerine, but it is still too sensitive to be used alone.

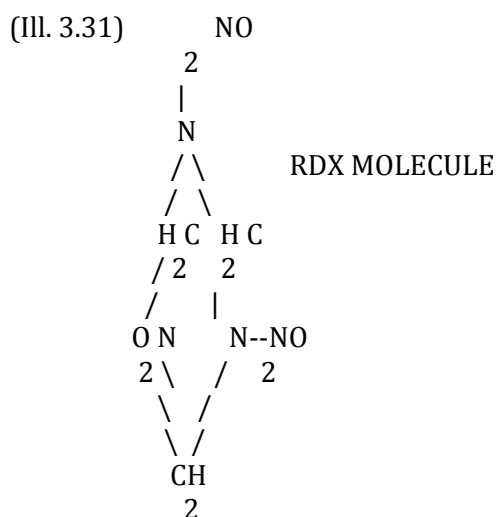

R.D.X. can be made by the surprisingly simple method outlined hereafter. It is much easier to make in the home than all other high explosives, with the possible exception of ammonium nitrate.

- | MATERIALS                         | EQUIPMENT                           |
|-----------------------------------|-------------------------------------|
| hexamine                          | 500 ml beaker                       |
| or                                |                                     |
| methenamine                       | glass stirring rod                  |
| fuel tablets (50 g)               | funnel and filter paper             |
| concentrated nitric acid (550 ml) | ice bath container (plastic bucket) |
| distilled water                   | centigrade thermometer              |
| table salt                        | blue litmus paper                   |

ice                      ammonium nitrate

- 1) Place the beaker in the ice bath, (see section 3.13, steps 3-4) and carefully pour 550 ml of concentrated nitric acid into the beaker.
- 2) When the acid has cooled to below 20 degrees centigrade, add small amounts of the crushed fuel tablets to the beaker. The temperature will rise, and it must be kept below 30 degrees centigrade, or dire consequences could result. Stir the mixture.
- 3) Drop the temperature below zero degrees centigrade, either by adding more ice and salt to the old ice bath, or by creating a new ice bath. Or, ammonium nitrate could be added to the old ice bath, since it becomes cold when it is put in water. Continue stirring the mixture, keeping the temperature below zero degrees centigrade for at least twenty minutes
- 4) Pour the mixture into a litre of crushed ice. Shake and stir the mixture, and allow it to melt. Once it has melted, filter out the crystals, and dispose of the corrosive liquid.
- 5) Place the crystals into one half a litre of boiling distilled water. Filter the crystals, and test them with the blue litmus paper. Repeat steps 4 and 5 until the litmus paper remains blue. This will make the crystals more stable and safe.
- 6) Store the crystals wet until ready for use. Allow them to dry completely using them. R.D.X. is not stable enough to use alone as an explosive.
- 7) Composition C-1 can be made by mixing 88.3% R.D.X. (by weight) with 11.1% mineral oil, and 0.6% lecithin. Knead these material together in a plastic bag. This is one way to desensitize the explosive.
- 8) H.M.X. is a mixture of T.N.T. and R.D.X.; the ratio is 50/50, by weight. it is not as sensitive, and is almost as powerful as straight R.D.X.
- 9) By adding ammonium nitrate to the crystals of R.D.X. after step 5, it should be possible to desensitize the R.D.X. and increase its power, since ammonium nitrate is very insensitive and powerful. Sodium or potassium nitrate could also be added; a small quantity is sufficient to stabilize the R.D.X.
- 10) R.D.X. detonates at a rate of 8550 meters/second when it is compressed to a density of 1.55 g/cubic cm.

### 3.32 AMMONIUM NITRATE

Ammonium nitrate could be made by a terrorist according to the haphazard method in section 2.33, or it could be stolen from a construction site, since it is usually used in blasting, because it is very stable and insensitive to shock and heat. A terrorist could also buy several Instant Cold-Paks from a drug store or medical supply store. The major disadvantage with ammonium nitrate, from a terrorist's point of view, would be detonating it. A rather

powerful priming charge must be used, and usually with a booster charge. The diagram below will explain.

(Ill. 3.32)

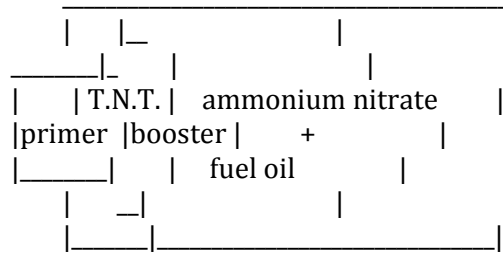

The primer explodes, detonating the T.N.T., which detonates, sending a tremendous shockwave through the ammonium nitrate, detonating it.

### 3.33 ANFOS

ANFO is an acronym for Ammonium Nitrate - Fuel Oil Solution. An ANFO solves the only other major problem with ammonium nitrate: its tendency to pick up water vapor from the air. This results in the explosive failing to detonate when such an attempt is made. This is rectified by mixing 94% (by weight) ammonium nitrate with 6% fuel oil, or kerosene. The kerosene keeps the ammonium nitrate from absorbing moisture from the air. An ANFO also requires a large shockwave to set it off.

#### 3.33.1 About ANFO (From Dean S.)

Lately there was been a lot said about various ANFO mixtures. These are mixtures of Ammonium Nitrate with Fuel Oil. This forms a reasonably powerful commercial explosive, with its primary benefit being the fact that it is cheap. Bulk ANFO should run somewhere around 9-12 cents the pound. This is dirt cheap compared to 40% nitro gel dynamites at 1 to 2 dollars the pound. To keep the cost down, it is frequently mixed at the borehole by a bulk truck, which has a pneumatic delivery hopper of AN prills (thats pellets to most of the world) and a tank of fuel oil. It is strongly recommended that a dye of some sort, preferably red be added to the fuel oil to make it easier to distinguish treated AN explosive from untreated oxidizer.

ANFO is not without its problems. To begin with, it is not that sensitive to detonation. Number eight caps are not reliable when used with ANFO. Booster charges must be used to avoid dud blast holes. Common boosters include sticks of various dynamites, small pours of water gel explosives, dupont's detaprime cast boosters, and Atlas's power primer cast explosive. The need to use boosters raises the cost. Secondly, ANFO is very water susceptible. It dissolves in it, or absorbes it from the atmosphere, and becomes quite worthless real quick. It must be protected from water with borehole liners, and still must be shot real quick. Third, ANFO has a low density, somewhere around .85. This means ANFO sacks float, which is no good, and additionally, the low density means the power is somewhat low. Generally, the more weight of explosive one can place in a hole, the more effective. ANFO blown into the hole with a pneumatic system fractures as it is places,

raising the density to about .9 or .92. The delivery system adds to the cost, and must be anti static in nature. Aluminum is added to some commercial, cartridge packaged ANFOs to raise the density---this also raises power considerable, and a few of these mixtures are reliably cap sensitive.

Now than, for formulations. An earlier article mentioned 2.5 kilos of ammonium nitrate, and I believe 5 to 6 liters of diesel. This mixture is extremely over fueled, and I'd be surprised if it worked. Dupont recommends a AN to FO ratio of 93% AN to 7% FO by weight. Hardly any oil at all. More oil makes the mixture less explosive by absorbing detonation energy, and excess fuel makes detonation byproducts health hazzards as the mixture is oxygen poor. Note that commercial fertilizer products do not work as well as the porous AN prills dupont sells, because fertilizers are coated with various materials meant to seal them from moisture, which keep the oil from being absorbed.

Another problem with ANFO: for reliable detonation, it needs confinement, either from a casing, borehole, etc, or from the mass of the charge. Thus, a pile of the stuff with a booster in it is likely to scatter and burn rather than explode when the booster is shot. In boreholes, or reasonable strong casings (cardboard, or heavy plastic film sacks) the stuff detonated quite well. So will big piles. Thats how the explosive potential was discovered: a small oil freighter rammed a bulk chemical ship. Over several hours the cargoes intermixed to some degree, and reached critical mass. Real big bang. A useful way to obtain the containment needed is to replace the fuel oil with a wax fuel. Mix the AN with just enough melted wax to form a cohesive mixture, mold into shape. The wax fuels, and retains the mixture. This is what the US military uses as a man placed cratering charge. The military literature states this can be set off by a blasting cap, but it is important to remember the military blasting caps are considerable more powerful than commercial ones. The military rightly insists on reliability, and thus a strong cap (maybe 70-80 percent stronger than commercial). They also tend to go overboard when calculating demolition charges...., but then hey, who doesn't...

Two manuals of interest: Duponts "Blaster's Handbook", a \$20 manual mainly useful for rock and seismographic operations. Atlas's "Powder Manual" or "Manual of Rock Blasting" (I forget the title, its in the office). This is a \$60 book, well worth the cash, dealing with the above two topics, plus demolitions, and non-quarry blasting.

Incidentally, combining fuel oil and ammonium nitrate constitutes the manufacture of a high explosive, and requires a federal permit to manufacture and store. Even the mines that mix it on site require the permit to manufacture. Those who don't manufacture only need permits to store. Those who don't store need no permits, which includes most of us: anyone, at least in the US may purchase explosives, provided they are 21 or older, and have no criminal record. Note they ought to be used immediately, because you do need a liscence to store. Note also that commercial explosives contain quantities of tracing agents, which make it real easy for the FBI to trace the explosion to the purchaser, so please, nobody blow up any banks, orphanages, or old folks homes, okay.

D. S.- Civil Engineer at large.

### 3.34 T.N.T.

T.N.T., or Tri-Nitro-Toluene, is perhaps the second oldest known high explosive. Dynamite, of course, was the first. It is certainly the best known high explosive, since it has been popularized by early morning cartoons. It is the standard for comparing other explosives to, since it is the most well known. In industry, a T.N.T. is made by a three step nitration process that is designed to conserve the nitric and sulfuric acids which are used to make the product. A terrorist, however, would probably opt for the less economical one step method. The one step process is performed by treating toluene with very strong (fuming) sulfuric acid. Then, the sulfated toluene is treated with very strong (fuming) nitric acid in an ice bath. Cold water is added the solution, and it is filtered.

### 3.35 POTASSIUM CHLORATE

Potassium chlorate itself cannot be made in the home, but it can be obtained from labs. If potassium chlorate is mixed with a small amount of vaseline, or other petroleum jelly, and a shockwave is passed through it, the material will detonate with slightly more power than black powder. It must, however, be confined to detonate it in this manner. The procedure for making such an explosive is outlined below:

MATERIALS	EQUIPMENT
ÄÄÄÄÄÄÄÄÄÄ	ÄÄÄÄÄÄÄÄÄÄ
potassium chlorate (9 parts, by volume)	zip-lock plastic bag
petroleum jelly (vaseline) (1 part, by volume)	clay grinding bowl or wooden bowl and wooden spoon

- 1) Grind the potassium chlorate in the grinding bowl carefully and slowly, until the potassium chlorate is a very fine powder. The finer that it is powdered, the faster (better) it will detonate.
- 2) Place the powder into the plastic bag. Put the petroleum jelly into the plastic bag, getting as little on the sides of the bag as possible, i.e. put the vaseline on the potassium chlorate powder.
- 3) Close the bag, and kneed the materials together until none of the potassium chlorate is dry powder that does not stick to the main glob. If necessary, add a bit more petroleum jelly to the bag.
- 4) The material must me used within 24 hours, or the mixture will react to greatly reduce the effectiveness of the explosive. This reaction, however, is harmless, and releases no heat or dangerous products.

### 3.36 DYNAMITE

The name dynamite comes from the Greek word "dynamis", meaning power. Dynamite was invented by Nobel shortly after he made nitroglycerine. It was made because nitroglycerine was so dangerously sensitive to shock. A misguided individual with some sanity would, after making nitroglycerine (an insane act) would immediately convert it to dynamite. This can be done by adding various materials to the nitroglycerine, such as sawdust. The sawdust holds a large weight of nitroglycerine per volume. Other materials, such as ammonium nitrate could be added, and they would tend to desensitize the explosive, and increase the power. But even these nitroglycerine compounds are not really safe.

### 3.37 NITROSTARCH EXPLOSIVES

Nitrostarch explosives are simple to make, and are fairly powerful. All that need be done is treat various starches with a mixture of concentrated nitric and sulfuric acids. 10 ml of concentrated sulfuric acid is added to 10 ml of concentrated nitric acid. To this mixture is added 0.5 grams of starch. Cold water is added, and the apparently unchanged nitrostarch is filtered out. Nitrostarch explosives are of slightly lower power than T.N.T., but they are more readily detonated.

### 3.38 PICRIC ACID

Picric acid, also known as Tri-Nitro-Phenol, or T.N.P., is a military explosive that is most often used as a booster charge to set off another less sensitive explosive, such as T.N.T. It another explosive that is fairly simple to make, assuming that one can acquire the concentrated sulfuric and nitric acids. Its procedure for manufacture is given in many college chemistry lab manuals, and is easy to follow. The main problem with picric acid is its tendency to form dangerously sensitive and unstable picrate salts, such as potassium picrate. For this reason, it is usually made into a safer form, such as ammonium picrate, also called explosive D. A social deviant would probably use a formula similar to the one presented here to make picric acid.

MATERIALS	EQUIPMENT
phenol (9.5 g)	500 ml flask
concentrated sulfuric acid (12.5 ml)	adjustable heat source
concentrated nitric acid (38 ml)	1000 ml beaker or other container suitable for boiling in
distilled water	filter paper and funnel
	glass stirring rod

- 1) Place 9.5 grams of phenol into the 500 ml flask, and carefully add 12.5 ml of concentrated sulfuric acid and stir the mixture.

- 2) Put 400 ml of tap water into the 1000 ml beaker or boiling container and bring the water to a gentle boil.
- 3) After warming the 500 ml flask under hot tap water, place it in the boiling water, and continue to stir the mixture of phenol and acid for about thirty minutes. After thirty minutes, take the flask out, and allow it to cool for about five minutes.
- 4) Pour out the boiling water used above, and after allowing the container to cool, use it to create an ice bath, similar to the one used in section 3.13, steps 3-4. Place the 500 ml flask with the mixed acid and phenol in the ice bath. Add 38 ml of concentrated nitric acid in small amounts, stirring the mixture constantly. A vigorous but "harmless" reaction should occur. When the mixture stops reacting vigorously, take the flask out of the ice bath.
- 5) Warm the ice bath container, if it is glass, and then begin boiling more tap water. Place the flask containing the mixture in the boiling water, and heat it in the boiling water for 1.5 to 2 hours.
- 6) Add 100 ml of cold distilled water to the solution, and chill it in an ice bath until it is cold.
- 7) Filter out the yellowish-white picric acid crystals by pouring the solution through the filter paper in the funnel. Collect the liquid and dispose of it in a safe place, since it is corrosive.
- 8) Wash out the 500 ml flask with distilled water, and put the contents of the filter paper in the flask. Add 300 ml of water, and shake vigorously.
- 9) Re-filter the crystals, and allow them to dry.
- 10) Store the crystals in a safe place in a glass container, since they will react with metal containers to produce picrates that could explode spontaneously.

### 3.39 AMMONIUM PICRATE

Ammonium picrate, also called Explosive D, is another safety explosive. It requires a substantial shock to cause it to detonate, slightly less than that required to detonate ammonium nitrate. It is much safer than picric acid, since it has little tendency to form hazardous unstable salts when placed in metal containers. It is simple to make from picric acid and clear household ammonia. All that need be done is put the picric acid crystals into a glass container and dissolve them in a great quantity of hot water. Add clear household ammonia in excess, and allow the excess ammonia to evaporate. The powder remaining should be ammonium picrate.

### 3.40 NITROGEN TRICHLORIDE

Nitrogen trichloride, also known as chloride of azode, is an oily yellow liquid. It explodes violently when it is heated above 60 degrees celsius, or

when it comes in contact with an open flame or spark. It is fairly simple to produce.

- 1) In a beaker, dissolve about 5 teaspoons of ammonium nitrate in water. Do not put so much ammonium nitrate into the solution that some of it remains undissolved in the bottom of the beaker.
- 2) Collect a quantity of chlorine gas in a second beaker by mixing hydrochloric acid with potassium permanganate in a large flask with a stopper and glass pipe.
- 3) Place the beaker containing the chlorine gas upside down on top of the beaker containing the ammonium nitrate solution, and tape the beakers together. Gently heat the bottom beaker. When this is done, oily yellow droplets will begin to form on the surface of the solution, and sink down to the bottom. At this time, remove the heat source immediately.

Alternately, the chlorine can be bubbled through the ammonium nitrate solution, rather than collecting the gas in a beaker, but this requires timing and a stand to hold the beaker and test tube.

The chlorine gas can also be mixed with anhydrous ammonia gas, by gently heating a flask filled with clear household ammonia. Place the glass tubes from the chlorine-generating flask and the tube from the ammonia-generating flask in another flask that contains water.

- 4) Collect the yellow droplets with an eyedropper, and use them immediately, since nitrogen trichloride decomposes in 24 hours.

### 3.41 LEAD AZIDE

Lead Azide is a material that is often used as a booster charge for other explosive, but it does well enough on its own as a fairly sensitive explosive. It does not detonate too easily by percussion or impact, but it is easily detonated by heat from an igniter wire, or a blasting cap. It is simple to produce, assuming that the necessary chemicals can be procured.

By dissolving sodium azide and lead acetate in water in separate beakers, the two materials are put into an aqueous state. Mix the two beakers together, and apply a gentle heat. Add an excess of the lead acetate solution, until no reaction occurs, and the precipitate on the bottom of the beaker stops forming.

Filter off the solution, and wash the precipitate in hot water. The precipitate is lead azide, and it must be stored wet for safety. If lead acetate cannot be found, simply acquire acetic acid, and put lead metal in it. Black powder bullets work well for this purpose.

### 3.5 OTHER "EXPLOSIVES"

The remaining section covers the other types of materials that can be used to destroy property by fire. Although none of the materials presented here are explosives, they still produce explosive-style results.

### 3.51 THERMITE

Thermite is a fuel-oxidizer mixture that is used to generate tremendous amounts of heat. It was not presented in section 3.23 because it does not react nearly as readily. It is a mixture of iron oxide and aluminum, both finely powdered. When it is ignited, the aluminum burns, and extracts the oxygen from the iron oxide. This is really two very exothermic reactions that produce a combined temperature of about 2200 degrees C. This is half the heat energy produced by an atomic weapon. It is difficult to ignite, however, but when it is ignited, it is one of the most effective firestarters around.

#### MATERIALS

ÄÄÄÄÄÄÄÄÄÄ

powdered aluminum (10 g)    powdered iron oxide (10 g)

- 1) There is no special procedure or equipment required to make thermite. Simply mix the two powders together, and try to make the mixture as homogenous as possible. The ratio of iron oxide to aluminum is 50% / 50% by weight, and be made in greater or lesser amounts.
- 2) Ignition of thermite can be accomplished by adding a small amount of potassium chlorate to the thermite, and pouring a few drops of sulfuric acid on it. This method and others will be discussed later in section 4.33. The other method of igniting thermite is with a magnesium strip. Finally, by using common sparkler-type fireworks placed in the thermite, the mixture can be ignited.

### 3.52 MOLOTOV COCKTAILS

First used by Russians against German tanks, the Molotov cocktail is now exclusively used by terrorists worldwide. They are extremely simple to make, and can produce devastating results. By taking any highly flammable material, such as gasoline, diesel fuel, kerosene, ethyl or methyl alcohol, lighter fluid, turpentine, or any mixture of the above, and putting it into a large glass bottle, anyone can make an effective firebomb. After putting the flammable liquid in the bottle, simply put a piece of cloth that is soaked in the liquid in the top of the bottle so that it fits tightly.

Then, wrap some of the cloth around the neck and tie it, but be sure to leave a few inches of loose cloth to light. Light the exposed cloth, and throw the bottle. If the burning cloth does not go out, and if the bottle breaks on impact, the contents of the bottle will spatter over a large area near the site of impact, and burst into flame.

Flammable mixtures such as kerosene and motor oil should be mixed with a more volatile and flammable liquid, such as gasoline, to insure ignition. A mixture such as tar or grease and gasoline will stick to the surface that it strikes, and burn hotter, and be more difficult to extinguish. A mixture such as this must be shaken well before it is lit and thrown

### 3.53 CHEMICAL FIRE BOTTLE

The chemical fire bottle is really an advanced molotov cocktail. Rather than using the burning cloth to ignite the flammable liquid, which has at best a fair chance of igniting the liquid, the chemical fire bottle utilizes the very hot and violent reaction between sulfuric acid and potassium chlorate. When the container breaks, the sulfuric acid in the mixture of gasoline sprays onto the paper soaked in potassium chlorate and sugar. The paper, when struck by the acid, instantly bursts into a white flame, igniting the gasoline. The chance of failure to ignite the gasoline is less than 2%, and can be reduced to 0%, if there is enough potassium chlorate and sugar to spare.

#### MATERIALS

ÄÄÄÄÄÄÄÄÄÄ

potassium chlorate  
(2 teaspoons)

sugar (2 teaspoons)

conc. sulfuric acid (4 oz.)

gasoline (8 oz.)

#### EQUIPMENT

ÄÄÄÄÄÄÄÄÄÄ

12 oz.glass bottle

cap for bottle, w/plastic inside

cooking pan with raised edges

paper towels

glass or plastic cup and spoon

- 1) Test the cap of the bottle with a few drops of sulfuric acid to make sure that the acid will not eat away the bottle cap during storage. If the acid eats through it in 24 hours, a new top must be found and tested, until a cap that the acid does not eat through is found. A glass top is excellent.
- 2) Carefully pour 8 oz. of gasoline into the glass bottle.
- 3) Carefully pour 4 oz. of concentrated sulfuric acid into the glass bottle. Wipe up any spills of acid on the sides of the bottle, and screw the cap on the bottle. Wash the bottle's outside with plenty of water. Set it aside to dry.
- 4) Put about two teaspoons of potassium chlorate and about two teaspoons of sugar into the glass or plastic cup. Add about 1/2 cup of boiling water, or enough to dissolve all of the potassium chlorate and sugar.
- 5) Place a sheet of paper towel in the cooking pan with raised edges. Fold the paper towel in half, and pour the solution of dissolved potassium chlorate and sugar on it until it is thoroughly wet. Allow the towel to dry.
- 6) When it is dry, put some glue on the outside of the glass bottle containing the gasoline and sulfuric acid mixture. Wrap the paper towel around the bottle, making sure that it sticks to it in all places. Store the bottle in a place where it will not be broken or tipped over.
- 7) When finished, the solution in the bottle should appear as two distinct liquids, a dark brownish-red solution on the bottom, and a clear solution

on top. The two solutions will not mix. To use the chemical fire bottle, simply throw it at any hard surface.

8) NEVER OPEN THE BOTTLE, SINCE SOME SULFURIC ACID MIGHT BE ON THE CAP, WHICH COULD TRICKLE DOWN THE SIDE OF THE BOTTLE AND IGNITE THE POTASSIUM CHLORATE, CAUSING A FIRE AND/OR EXPLOSION.

9) To test the device, tear a small piece of the paper towel off the bottle, and put a few drops of sulfuric acid on it. The paper towel should immediately burst into a white flame.

### 3.54 BOTTLED GAS EXPLOSIVES

Bottled gas, such as butane for refilling lighters, propane for propane stoves or for bunsen burners, can be used to produce a powerful explosion. To make such a device, all that a simple-minded anarchist would have to do would be to take his container of bottled gas and place it above a can of Sterno or other gelatinized fuel, light the fuel and run. Depending on the fuel used, and on the thickness of the fuel container, the liquid gas will boil and expand to the point of bursting the container in about five minutes.

In theory, the gas would immediately be ignited by the burning gelatinized fuel, producing a large fireball and explosion. Unfortunately, the bursting of the bottled gas container often puts out the fuel, thus preventing the expanding gas from igniting. By using a metal bucket half filled with gasoline, however, the chances of ignition are better, since the gasoline is less likely to be extinguished. Placing the canister of bottled gas on a bed of burning charcoal soaked in gasoline would probably be the most effective way of securing ignition of the expanding gas, since although the bursting of the gas container may blow out the flame of the gasoline, the burning charcoal should immediately re-ignite it. Nitrous oxide, hydrogen, propane, acetylene, or any other flammable gas will do nicely.

During the recent gulf war, fuel/air bombs were touted as being second only to nuclear weapons in their devastating effects. These are basically similar to the above devices, except that an explosive charge is used to rupture the fuel container and disperse it over a wide area. a second charge is used to detonate the fuel. The reaction is said to produce a massive shockwave and to burn all the oxygen in a large area, causing suffocation.

Another benefit of a fuel-air explosive is that the gas will seep into fortified bunkers and other partially-sealed spaces, so a large bomb placed in a building would result in the destruction of the majority of surrounding rooms, rendering it structurally unsound.

### 3.6 Fun with dry ice... LOTS of fun with dry ice. (from the Usenet.)

There is no standard formula for a dry ice bomb, however a generic form is as follows:

Take a 2-liter soda bottle, empty it completely, then add about 3/4 Lb of

Dry Ice (crushed works best) and (optional) a quantity of water.

Depending on the condition of the bottle, the weather, and the amount and temperature of the bottle the bomb will go off in 30 seconds - 5 minutes. Without any water added, the 2-liter bottles will go often in 3-7 minutes if dropped into a warm river, and in 45 minutes to 1 1/2 hours in open air.

The explosion sounds equivalent to an M-100. Plastic 16 oz. soda bottles and 1 liter bottles work almost as well as do the 2-liters, however glass bottles aren't nearly as loud, and can produce dangerous shrapnel.

Remember, these are LOUD! Dorian, a classmate of mine, set up 10 bottles in a nearby park without adding water. After the first two went off (there was about 10 minutes between explosions) the Police arrived and spent the next hour trying to find the guy who they thought was setting off M-100's all around them...

#### USES FOR DRY ICE

##### Time Bombs:

1. Get a small plastic container with lid (we used the small plastic cans that hold the coaters used for large-format Polaroid film). A film canister would probably work; the key is, it should seal tightly and take a fair amount of effort to open).

Place a chunk of dry ice in the can, put on the lid without quite sealing it. Put the assembled bomb in your pocket, or behind your back.

Approach the mark and engage in normal conversation. When his attention is drawn away, quickly seal the lid on the bomb, deposit it somewhere within a few feet of the mark, out of obvious sight, then leave.

Depending on variables (you'll want to experiment first), you'll hear a loud "pop" and an even louder "Aarrggghh!" within a minute, when the CO<sub>2</sub> pressure becomes sufficient to blow off the lid.

In a cluttered lab, this is doubly nasty because the mark will probably never figure out what made the noise.

2. Put 2-3 inches of water in a 2-liter plastic pop bottle. Put in as many chunks of dry ice as possible before the smoke gets too thick. Screw on the cap, place in an appropriate area, and run like hell. After about a minute (your mileage may vary), a huge explosion will result, spraying water everywhere, along with what's left of the 2-liter bottle.

##### More things to do with Dry Ice:

Has anyone ever thrown dry ice into a public pool? As long as you chuck it into the bottom of the deep end, it's safe, and it's really impressive if the water is warm enough

"Fun stuff. It SCREAMS when it comes into contact with metal..."

"You can safely hold a small piece of dry ice in your mouth if you KEEP IT MOVING CONSTANTLY. It looks like you're smoking or on fire."

Editor's Note: Dry ice can be a lot of fun, but be forewarned:

Using anything but plastic to contain dry ice bombs is suicidal. Dry ice is more dangerous than TNT, because it's extremely unpredictable. Even a 2-liter bottle can produce some nasty shrapnel: One source tells me that he caused an explosion with a 2-liter bottle that destroyed a metal garbage can. In addition, it is rumored that several kids have been killed by shards of glass resulting from the use of a glass bottle. For some reason, dry ice bombs have become very popular in the state of Utah. As a result, dry ice bombs have been classified as infernal devices, and possession is a criminal offense.

#### 4.0 USING EXPLOSIVES

Once a terrorist has made his explosives, the next logical step is to apply them. Explosives have a wide range of uses, from harassment, to vandalism, to assassination. **NONE OF THE IDEAS PRESENTED HERE ARE EVER TO BE CARRIED OUT, EITHER IN PART OR IN FULL! DOING SO CAN LEAD TO PROSECUTION, FINES, AND IMPRISONMENT!** The first step that a person that would use explosive would take would be to determine how big an explosive device would be needed to do whatever had to be done. Then, he would have to decide what to make his bomb with. He would also have to decide on how he wanted to detonate the device, and determine where the best placement for it would be. Then, it would be necessary to see if the device could be put where he wanted it without it being discovered or moved. Finally, he would actually have to sit down and build his explosive device. These are some of the topics covered in the next section.

#### 4.1 SAFETY

There is no such thing as a "safe" explosive device. One can only speak in terms of relative safety, or less unsafe.

#### 4.11 HOW NOT TO GET KILLED (Ways to avoid scoring an "Own Goal")

An "own goal" is the death of a person on your side from one of your own devices. It is obvious that these should be avoided at all costs. While no safety device is 100% reliable, it is usually better to err on the side of caution.

#### BASIC SAFETY RULES

- 1) DON'T SMOKE! (don't laugh- an errant cigarette wiped out the Weathermen)
- 2) GRIND ALL INGREDIENTS SEPERATELY. It's suprising how friction sensitive some supposedly "safe" explosives really are.
- 3) ALLOW for a 20% margin of error- Just because the AVERAGE burning rate of a fuse is 30 secs/foot, don't depend on the 5 inches sticking out of your pipe bomb to take exactly 2.5 minutes.
- 4) OVERESTIMATE THE RANGE OF YOUR SHRAPNEL. The cap from a pipe bomb can oftentravel a block or more at high velocities before coming to rest- If you have to stay nearby, remember that if you can see it, it can kill you.
- 5) When mixing sensitive compounds (such as flash powder) avoid all sources of static electricity. Mix the ingredients by the method below:

#### 4.12 HOW TO MIX INGREDIENTS

The best way to mix two dry chemicals to form an explosive is to do as the small-scale fireworks manufacturer's do:

Ingredients:

1 large sheet of smooth paper (for example a page from a newspaper that does not use staples)

The dry chemicals needed for the desired compound.

- 1) Measure out the appropriate amounts of the two chemicals, and pour them in two small heaps near opposite corners of the sheet.
- 2) Pick up the sheet by the two corners near the powders, allowing the powders to roll towards the middle of the sheet.
- 3) By raising one corner and then the other, roll the powders back and forth in the middle of the open sheet, taking care not to let the mixture spill from either of the loose ends.
- 4) Pour the powder off from the middle of the sheet, and use immediately. If it must be stored use airtight containers (35mm film canisters work nicely) and store away from people, houses, and valuable items.

## 4.2 IGNITION DEVICES

There are many ways to ignite explosive devices. There is the classic "light the fuse, throw the bomb, and run" approach, and there are sensitive mercury switches, and many things in between. Generally, electrical detonation systems are safer than fuses, but there are times when fuses are more appropriate than electrical systems; it is difficult to carry an electrical detonation system into a stadium, for instance, without being caught. A device with a fuse or impact detonating fuze would be easier to hide.

### 4.21 FUSE IGNITION

The oldest form of explosive ignition, fuses are perhaps the favorite type of simple ignition system. By simply placing a piece of waterproof fuse in a device, one can have almost guaranteed ignition. Modern waterproof fuse is extremely reliable, burning at a rate of about 2.5 seconds to the inch. It is available as model rocketry fuse in most hobby shops, and costs about \$3.00 for a nine-foot length. Cannon Fuse is a popular ignition system for pipe bombers because of its simplicity. All that need be done is light it with a match or lighter. Of course, if the Army had fuses like this, then the grenade, which uses fuse ignition, would be very impracticable. If a grenade ignition system can be acquired, by all means, it is the most effective. But, since such things do not just float around, the next best thing is to prepare a fuse system which does not require the use of a match or lighter, but still retains its simplicity. One such method is described below:

#### MATERIALS

strike-on-cover type matches      electrical tape or duct tape  
waterproof fuse

1) To determine the burn rate of a particular type of fuse, simply measure a 6 inch or longer piece of fuse and ignite it. With a stopwatch, press the start button the at the instant when the fuse lights, and stop the watch when the fuse reaches its end. Divide the time of burn by the length of fuse, and you have the burn rate of the fuse, in seconds per inch. This will be shown below:

Suppose an eight inch piece of fuse is burned, and its complete time of combustion is 20 seconds.

$$20 \text{ seconds} / 8 \text{ inches} = 2.5 \text{ seconds per inch.}$$

If a delay of 10 seconds was desired with this fuse, divide the desired time by the number of seconds per inch:

$$10 \text{ seconds} / 2.5 \text{ seconds per inch} = 4 \text{ inches}$$

NOTE: THE LENGTH OF FUSE HERE MEANS LENGTH OF FUSE TO THE POWDER. SOME FUSE, AT LEAST AN INCH, SHOULD BE INSIDE THE DEVICE. ALWAYS ADD THIS EXTRA INCH, AND PUT THIS EXTRA INCH AN INCH INTO THE DEVICE!!!

2) After deciding how long a delay is desired before the explosive device is to go off, add about 1/2 an inch to the premeasured amount of fuse, and cut it off.

3) Carefully remove the cardboard matches from the paper match case. Do not pull off individual matches; keep all the matches attached to the cardboard base. Take one of the cardboard match sections, and leave the other one to make a second igniter.

4) Wrap the matches around the end of the fuse, with the heads of the matches touching the very end of the fuse. Tape them there securely, making sure not to put tape over the match heads. Make sure they are very secure by pulling on them at the base of the assembly. They should not be able to move.

5) Wrap the cover of the matches around the matches attached to the fuse, making sure that the striker paper is below the match heads and the striker faces the match heads. Tape the paper so that is fairly tight around the matches. Do not tape the cover of the striker to the fuse or to the matches. Leave enough of the match book to pull on for ignition.

(Ill. 4.21)

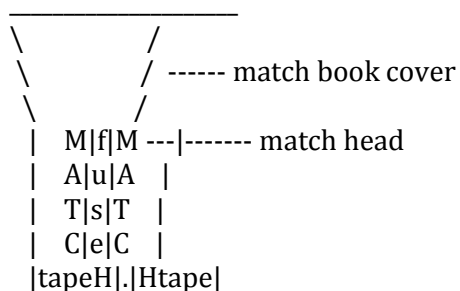

```

| |f| |
|#####u|#####|----- striking paper
|#####s|#####|
\ |e| /
\ |.| /
\ |f| /
\ |u| /
|ta|s|pe|
|ta|e|pe|
|. |
|f|
|u|
|s|
|e|
|. |
|_|

```

The match book is wrapped around the matches, and is taped to itself. The matches are taped to the fuse. The striker will rub against the matchheads when the match book is pulled.

- 6) When ready to use, simply pull on the match paper. It should pull the striking paper across the match heads with enough friction to light them. In turn, the burning matchheads will light the fuse, since it adjacent to the burning match heads.

#### 4.21.1 HOW TO MAKE BLACKMATCH FUSE:

Take a flat piece of plastic or metal (brass or aluminum are easy to work with and won't rust). Drill a 1/16th inch hole through it. This is your die for sizing the fuse. You can make fuses as big as you want, but this is the right size for the pipe bomb I will be getting to later.

To about 1/2 cup of black powder add water to make a thin paste. Add 1/2 teaspoon of corn starch. Cut some one foot lengths of cotton thread. Use cotton, not silk or thread made from synthetic fibers. Put these together until you have a thickness that fills the hole in the die but can be drawn through very easily.

Tie your bundle of threads together at one end. Separate the threads and hold the bundle over the black powder mixture. Lower the threads with a circular motion so they start curling onto the mixture. Press them under with the back of a teaspoon and continue lowering them so they coil into the paste. Take the end you are holding and thread it through the die. Pull it through smoothly in one long motion.

To dry your fuse, lay it on a piece of aluminum foil and bake it in your 250 degree oven or tie it to a grill in the oven and let it hang down. The fuse must be baked to make it stiff enough for the uses it will be put to later. Air drying will not do the job. If you used Sodium Nitrate, it will not even dry completely at room temperatures.

Cut the dry fuse with sissors into 2 inch lengths and store in an air tight

container. Handle this fuse carefully to avoid breaking it. You can also use a firecracker fuse if you have any available. The fuses can usually be pulled out without breaking. To give yourself some running time, you will be extending these fuses (blackmatch or firecracker fuse) with sulfured wick.

Finally, it is possible to make a relatively slow-burning fuse in the home. By dissolving about one teaspoon of black powder in about 1/4 a cup of boiling water, and, while it is still hot, soaking in it a long piece of all cotton string, a slow-burning fuse can be made. After the soaked string dries, it must then be tied to the fuse of an explosive device. Sometimes, the end of the slow burning fuse that meets the normal fuse has a charge of black powder or gunpowder at the intersection point to insure ignition, since the slow-burning fuse does not burn at a very high temperature.

A similar type of slow fuse can be made by taking the above mixture of boiling water and black powder and pouring it on a long piece of toilet paper. The wet toilet paper is then gently twisted up so that it resembles a firecracker fuse, and is allowed to dry.

#### 4.21.2 HOW TO MAKE SULFURED WICK

Use heavy cotton string about 1/8th inch in diameter. You can find some at a garden supply for tying up your tomatoes. Be sure it's cotton. You can test it by lighting one end. It should continue to burn after the match is removed and when blown out will have a smoldering coal on the end. Put some sulfur in a small container like a small pie pan and melt it in the oven at 250 degrees.

It will melt into a transparent yellow liquid. If it starts turning brown, it is too hot. Coil about a one foot length of string into it. The melted sulfur will soak in quickly. When saturated, pull it out and tie it up to cool and harden.

It can be cut to desired lengths with scissors. 2 inches is about right. These wicks will burn slowly with a blue flame and do not blow out easily in a moderate wind. They will not burn through a hole in a metal pipe, but are great for extending your other fuse. They will not throw off sparks. Blackmatch generates sparks which can ignite it along its length causing unpredictable burning times.

#### 4.22 IMPACT IGNITION

Impact ignition is an excellent method of ignition for spontaneous terrorist activities. The problem with an impact-detonating device is that it must be kept in a very safe container so that it will not explode while being transported to the place where it is to be used. This can be done by having a removable impact initiator.

The best and most reliable impact initiator is one that uses factory made initiators or primers. A no. 11 cap for black powder firearms is one such primer. They usually come in boxes of 100, and cost about \$2.50. To use such a cap, however, one needs a nipple that it will fit on. Black powder nipples are

also available in gun stores. All that a person has to do is ask for a package of nipples and the caps that fit them. Nipples have a hole that goes all the way through them, and they have a threaded end, and an end to put the cap on. A cutaway of a nipple is shown below:

(Ill. 4.22)

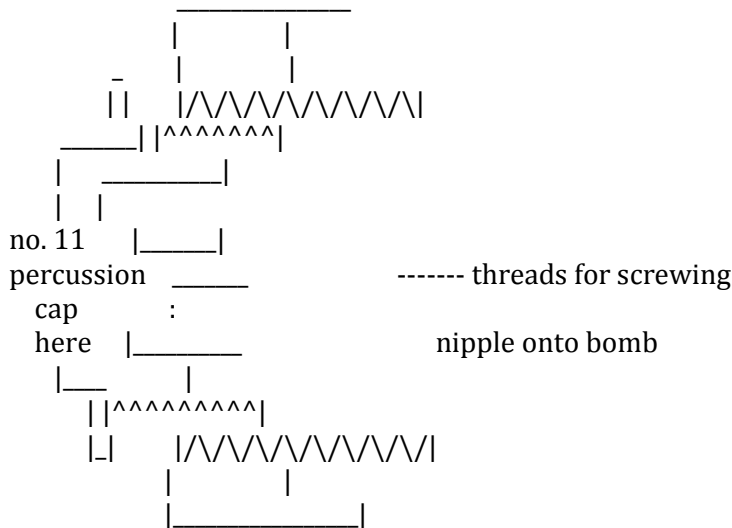

When making using this type of initiator, a hole must be drilled into whatever container is used to make the bomb out of. The nipple is then screwed into the hole so that it fits tightly. Then, the cap can be carried and placed on the bomb when it is to be thrown. The cap should be bent a small amount before it is placed on the nipple, to make sure that it stays in place. The only other problem involved with an impact detonating bomb is that it must strike a hard surface on the nipple to set it off. By attaching fins or a small parachute on the end of the bomb opposite the primer, the bomb, when thrown, should strike the ground on the primer, and explode. Of course, a bomb with mercury fulminate in each end will go off on impact regardless of which end it strikes on, but mercury fulminate is also likely to go off if the person carrying the bomb is bumped hard.

#### 4.22.1 MAGICUBE IGNITOR

A VERY SENSITIVE and reliable impact initiator can be produced from the common MAGICUBE (\$2.40 for 12) type flashbulbs. Simply crack the plastic cover off, remove the reflector, and you will see 4 bulbs, each of which has a small metal rod holding it in place.

CAREFULLY grasp this rod with a pair of needle-nose pliers, and pry gently upwards, making sure that NO FORCE IS APPLIED TO THE GLASS BULB.

Each bulb is coated with plastic, which must be removed for them to be effective in our application. This coating can be removed by soaking the bulbs in a small glass of acetone for 30-45 minutes, at which point the plastic can be easily peeled away.

The best method to use these is to dissolve some nitrocellulose based

smokeless powder in acetone and/or ether, forming a thick glue-like paste. Coat the end of the fuse with this paste, then stick the bulb (with the metal rod facing out) into the paste. About half the bulb should be completely covered, and if a VERY THIN layer of nitrocellulose is coated over the remainder then ignition should be very reliable.

To insure that the device lands with the bulb down, a small streamer can be attached to the opposite side, so when it is tossed high into the air the appropriate end will hit the ground first.

#### 4.23 ELECTRICAL IGNITION

Electrical ignition systems for detonation are usually the safest and most reliable form of ignition. Electrical systems are ideal for demolition work, if one doesn't have to worry so much about being caught. With two spools of 500 ft of wire and a car battery, one can detonate explosives from a "safe", comfortable distance, and be sure that there is nobody around that could get hurt. With an electrical system, one can control exactly what time a device will explode, within fractions of a second. Detonation can be aborted in less than a second's warning, if a person suddenly walks by the detonation sight, or if a police car chooses to roll by at the time. The two best electrical igniters are military squibs and model rocketry igniters. Blasting caps for construction also work well. Model rocketry igniters are sold in packages of six, and cost about \$1.00 per pack. All that need be done to use them is connect it to two wires and run a current through them. Military squibs are difficult to get, but they are a little bit better, since they explode when a current is run through them, whereas rocketry igniters only burst into flame. Most squibs will NOT detonate KClO<sub>3</sub>/petroleum jelly or RDX. This requires a blasting cap type detonation in most cases. There are, however, military explosive squibs which will do the job.

Igniters can be used to set off black powder, mercury fulminate, or guncotton, which in turn, can set off a high order explosive.

##### 4.23.1 HOW TO MAKE AN ELECTRIC FUZE (By Capt. Hack & GW)

Take a flashlight bulb and place its glass tip down on a file. Grind it down on the file until there is a hole in the end. Solder one wire to the case of the bulb and another to the center conductor at the end. Fill the bulb with black powder or powdered match head. One or two flashlight batteries will heat the filament in the bulb causing the powder to ignite.

##### 4.23.2 ANOTHER ELECTRIC FUZE

Take a medium grade of steel wool and pull a strand out of it. Attach it to the ends of two pieces of copper wire by wrapping it around a few turns and then pinch on a small piece of solder to bind the strand to the wire. You want about 1/2 inch of steel strand between the wires. Number 18 or 20 is a good size wire to use.

Cut a 1/2 by 1 inch piece of cardboard of the type used in match covers. Place a small pile of powdered match head in the center and press it flat.

place the wires so the steel strand is on top of and in contact with the powder. Sprinkle on more powder to cover the strand.

The strand should be surrounded with powder and not touching anything else except the wires at its ends. Place a piece of blackmatch in contact with the powder. Now put a piece of masking tape on top of the lot, and fold it under on the two ends. Press it down so it sticks all around the powder.

The wires are sticking out on one side and the blackmatch on the other. A single flashlight battery will set this off.

#### 4.24 ELECTRO-MECHANICAL IGNITION

Electro-mechanical ignition systems are systems that use some type of mechanical switch to set off an explosive charge electrically. This type of switch is typically used in booby traps or other devices in which the person who places the bomb does not wish to be anywhere near the device when it explodes. Several types of electro-mechanical detonators will be discussed

##### 4.24.1 Mercury Switches

Mercury switches are a switch that uses the fact that mercury metal conducts electricity, as do all metals, but mercury metal is a liquid at room temperatures. A typical mercury switch is a sealed glass tube with two electrodes and a bead of mercury metal. It is sealed because of mercury's nasty habit of giving off brain-damaging vapors. The diagram below may help to explain a mercury switch.

(Ill. 4.24.1)

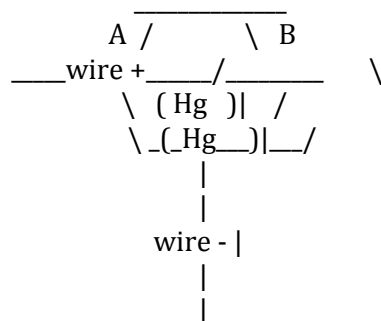

When the drop of mercury ("Hg" is mercury's atomic symbol) touches both contacts, current flows through the switch. If this particular switch was in its present position, A---B, current would be flowing, since the mercury can touch both contacts in the horizontal position.

If, however, it was in the | position, the drop of mercury would only touch the + contact on the A side. Current, then couldn't flow, since mercury does not reach both contacts when the switch is in the vertical position. This type of switch is ideal to place by a door. If it were placed in the path of a swinging door in the vertical position, the motion of the door would knock the switch down, if it was held to the ground by a piece of tape. This would tilt the switch into the vertical position, causing the mercury to touch both contacts, allowing current to flow through the mercury, and to the igniter or squib in an explosive device.

#### 4.24.2 Tripwire Switches

A tripwire is an element of the classic booby trap. By placing a nearly invisible line of string or fishing line in the probable path of a victim, and by putting some type of trap there also, nasty things can be caused to occur. If this mode of thought is applied to explosives, how would one use such a tripwire to detonate a bomb. The technique is simple. By wrapping the tips of a standard clothespin with aluminum foil, and placing something between them, and connecting wires to each aluminum foil contact, an electric tripwire can be made. If a piece of wood attached to the tripwire was placed between the contacts on the clothespin, the clothespin would serve as a switch. When the tripwire was pulled, the clothespin would snap together, allowing current to flow between the two pieces of aluminum foil, thereby completing a circuit, which would have the igniter or squib in it. Current would flow between the contacts to the igniter or squib, heat the igniter or squib, causing it to explode. Make sure that the aluminum foil contacts do not touch the spring, since the spring also conducts electricity.

#### 4.243 Radio Control Detonators

In the movies, every terrorist or criminal uses a radio controlled detonator to set off explosives. With a good radio detonator, one can be several miles away from the device, and still control exactly when it explodes, in much the same way as an electrical switch. The problem with radio detonators is that they are rather costly. However, there could possibly be a reason that a terrorist would wish to spend the amounts of money involved with a RC (radio control) system and use it as a detonator. If such an individual wanted to devise an RC detonator, all he would need to do is visit the local hobby store or toy store, and buy a radio controlled toy. Taking it back to his/her abode, all that he/she would have to do is detach the solenoid/motor that controls the motion of the front wheels of a RC car, or detach the solenoid/motor of the elevators/rudder of a RC plane, or the rudder of a RC boat, and re-connect the squib or rocket engine igniter to the contacts for the solenoid/motor. The device should be tested several times with squibs or igniters, and fully charged batteries should be in both the controller and the receiver (the part that used to move parts before the device became a detonator).

### 4.3 DELAYS

A delay is a device which causes time to pass from when a device is set up to the time that it explodes. A regular fuse is a delay, but it would cost quite a bit to have a 24 hour delay with a fuse. This section deals with the different types of delays that can be employed by a terrorist who wishes to be sure that his bomb will go off, but wants to be out of the country when it does.

#### 4.31 FUSE DELAYS

It is extremely simple to delay explosive devices that employ fuses for ignition. Perhaps the simplest way to do so is with a cigarette. An average cigarette burns for between 8-11 minutes. The higher the "tar" and nicotine

rating, the slower the cigarette burns. Low "tar" and nicotine cigarettes burn quicker than the higher "tar" and nicotine cigarettes, but they are also less likely to go out if left unattended, i.e. not smoked. Depending on the wind or draft in a given place, a high "tar" cigarette is better for delaying the ignition of a fuse, but there must be enough wind or draft to give the cigarette enough oxygen to burn. People who use cigarettes for the purpose of delaying fuses will often test the cigarettes that they plan to use in advance to make sure they stay lit and to see how long it will burn. Once a cigarettes burn rate is determined, it is a simple matter of carefully putting a hole all the way through a cigarette with a toothpick at the point desired, and pushing the fuse for a device in the hole formed.

(Ill 4.31)

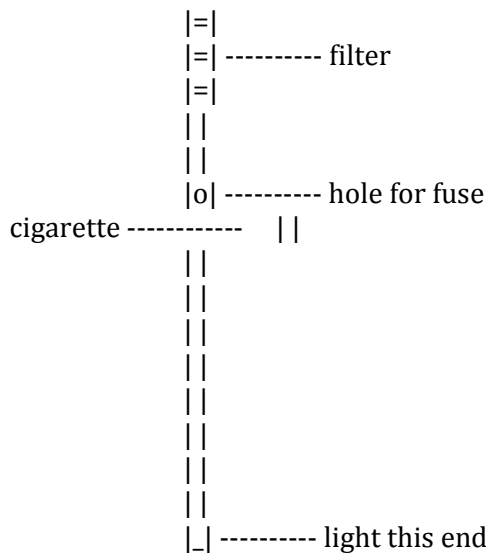

4.31.1 IMPROVED CIGARETTE DELAY (By Atur {THE pyromaniac })

A variation on the standard cigarette display was invented by my good friend Atur (THE Pyromaniac). Rather than inserting the fuse into the SIDE of the cigarette (and risk splitting it) half of the filter is cut off, and a small hole is punched THROUGH the remainder of the filter and into the tobacco.

(Ill. 4.31.1)

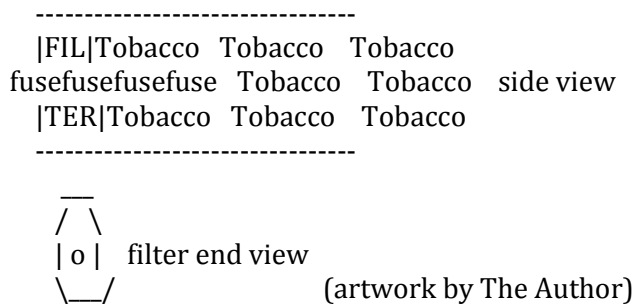

The fuse is inserted as far as possible into this hole, then taped or glued in place, or the cigarette can be cut and punched ahead of time and

lit normally, then attached to the fuse at the scene.

A similar type of device can be made from powdered charcoal and a sheet of paper. Simply roll the sheet of paper into a thin tube, and fill it with powdered charcoal. Punch a hole in it at the desired location, and insert a fuse. Both ends must be glued closed, and one end of the delay must be doused with lighter fluid before it is lit. Or, a small charge of gunpowder mixed with powdered charcoal could conceivably be used for igniting such a delay. A chain of charcoal briquettes can be used as a delay by merely lining up a few bricks of charcoal so that they touch each other, end on end, and lighting the first brick. Incense, which can be purchased at almost any novelty or party supply store, can also be used as a fairly reliable delay. By wrapping the fuse about the end of an incense stick, delays of up to 1/2 an hour are possible.

#### 4.32 TIMER DELAYS

Timer delays, or "time bombs" are usually employed by an individual who wishes to threaten a place with a bomb and demand money to reveal its location and means to disarm it. Such a device could be placed in any populated place if it were concealed properly. There are several ways to build a timer delay. By simply using a screw as one contact at the time that detonation is desired, and using the hour hand of a clock as the other contact, a simple timer can be made. The minute hand of a clock should be removed, unless a delay of less than an hour is desired.

The main disadvantage with this type of timer is that it can only be set for a maximum time of 12 hours. If an electronic timer is used, such as that in an electronic clock, then delays of up to 24 hours are possible. By removing the speaker from an electronic clock, and attaching the wires of a squib or igniter to them, a timer with a delay of up to 24 hours can be made. All that one has to do is set the alarm time of the clock to the desired time, connect the leads, and go away. This could also be done with an electronic watch, if a larger battery were used, and the current to the speaker of the watch was stepped up via a transformer. This would be good, since such a timer could be extremely small.

The timer in a VCR (Video Cassette Recorder) would be ideal. VCR's can usually be set for times of up to a week. The leads from the timer to the recording equipment would be the ones that an igniter or squib would be connected to. Also, one can buy timers from electronics stores that would work well. Finally, one could employ a digital watch, and use a relay, or electro-magnetic switch to fire the igniter, and the current of the watch would not have to be stepped up.

#### 4.33 CHEMICAL DELAYS

Chemical delays are uncommon, but they can be extremely effective in some cases. These were often used in the bombs the Germans dropped on England. The delay would ensure that a bomb would detonate hours or even days after the initial bombing raid, thereby increasing the terrifying effect on the British citizenry.

If a glass container is filled with concentrated sulfuric acid, and capped with several thicknesses of aluminum foil, or a cap that it will eat through, then it can be used as a delay. Sulfuric acid will react with aluminum foil to produce aluminum sulfate and hydrogen gas, and so the container must be open to the air on one end so that the pressure of the hydrogen gas that is forming does not break the container.

(Ill. 4.33)

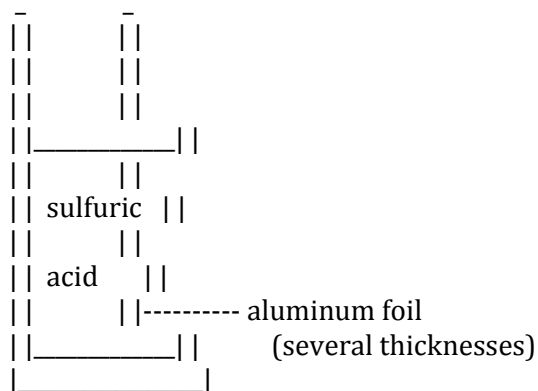

The aluminum foil is placed over the bottom of the container and secured there with tape. When the acid eats through the aluminum foil, it can be used to ignite an explosive device in several ways.

- 1) Sulfuric acid is a good conductor of electricity. If the acid that eats through the foil is collected in a glass container placed underneath the foil, and two wires are placed in the glass container, a current will be able to flow through the acid when both of the wires are immersed in the acid.
- 2) Sulfuric acid reacts very violently with potassium chlorate. If the acid drips down into a container containing potassium chlorate, the potassium chlorate will burst into flame. This flame can be used to ignite a fuse, or the potassium chlorate can be the igniter for a thermite bomb, if some potassium chlorate is mixed in a 50/50 ratio with the thermite, and this mixture is used as an igniter for the rest of the thermite.
- 3) Sulfuric acid reacts with potassium permanganate in a similar way.

#### 4.331 MORE SPONTANEOUS COMBUSTION

Some of the ingredients for these can only be had from a chemical supply so they are not my favorites. Look for powdered aluminum at a good painting supply.

##### METHOD # 1

Scatter out a few crystals of chromic anhydride. Drop on a little ethyl alcohol. It will burst into flame immediately.

##### METHOD # 2

Mix by weight, four parts ammonium chloride, one part ammonium nitrate, four parts powdered zinc. Pour out a small pile of this and make a depression on top. Put one or two drops of water in the depression. Stay well back from this.

#### METHOD # 3

Spoon out a small pile of powdered aluminum. Place a small amount of sodium peroxide on top of this. A volume the size of a small pea is about right. One drop of water will cause this to ignite in a blinding flare.

#### METHOD # 4

Mix by volume 3 parts concentrated sulfuric acid with 2 parts concentrated nitric acid. Hold a dropper of turpentine about 2 feet above the mixture. When drops strike the acid they will burst into flame.

### 4.4 EXPLOSIVE CASINGS

This section will cover everything from making a simple firecracker to a complicated scheme for detonating an insensitive high explosive, both of which are methods that could be utilized by perpetrators of terror.

#### 4.41 PAPER CONTAINERS

Paper was the first container ever used for explosives, since it was first used by the Chinese to make fireworks. Paper containers are usually very simple to make, and are certainly the cheapest. There are many possible uses for paper in containing explosives, and the two most obvious are in firecrackers and rocket engines. Simply by rolling up a long sheet of paper, and gluing it together, one can make a simple rocket engine. Perhaps a more interesting and dangerous use is in the firecracker. The firecracker shown here is one of Mexican design. It is called a "polumna", meaning "dove". The process of their manufacture is not unlike that of making a paper football. If one takes a sheet of paper about 16 inches in length by 1.5 inches wide, and fold one corner so that it looks like this:

(Ill 4.41)

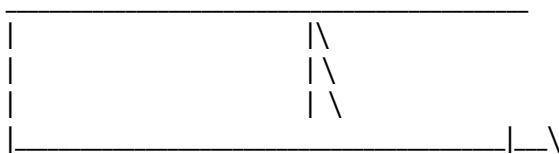

and then fold it again so that it looks like this:

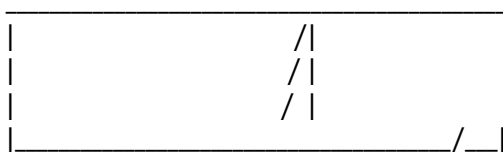

A pocket is formed. This pocket can be filled with black powder, pyrodex, flash powder, gunpowder, rocket engine powder, or any of the quick-burning fuel-oxidizer mixtures that occur in the form of a fine powder.

A fuse is then inserted, and one continues the triangular folds, being careful not to spill out any of the explosive. When the polumna is finished, it should be taped together very tightly, since this will increase the strength of the container, and produce a louder and more powerful explosion when it is lit. The finished polumna should look like a 1/4 inch - 1/3 inch thick triangle, like the one shown below:

(Ill. 4.41)

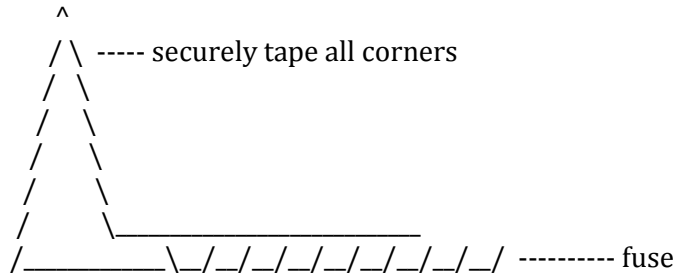

#### 4.42 METAL CONTAINERS

The classic pipe bomb is the best known example of a metal-contained explosive. Idiot anarchists take white tipped matches and cut off the match heads. They pound one end of a pipe closed with a hammer, pour in the white-tipped matches, and then pound the other end closed. This process often kills the fool, since when he pounds the pipe closed, he could very easily cause enough friction between the match heads to cause them to ignite and explode the unfinished bomb. By using pipe caps, the process is somewhat safer, and the less stupid anarchist would never use white tipped matches in a bomb. Regular matches may still be ignited by friction, but it is far less likely than with "strike-anywhere" matches.

He would buy two pipe caps and threaded pipe. First, he would drill a hole in one pipe cap, and put a fuse in it so that it will not come out, and so powder will not escape during handling. The fuse would be at least 3/4 an inch long inside the bomb. He would then screw the cap with the fuse in it on tightly, possibly putting a drop of super glue on it to hold it tight. He would then pour his explosive powder in the bomb. To pack it tightly, he would take a large wad of tissue paper and, after filling the pipe to the very top, carefully pack the powder down, by using the paper as a ramrod tip, and pushing it with a pencil or other wide ended object, until it would not move any further.

Finally, he would screw the other pipe cap on, and glue it. The tissue paper would help prevent some of the powder from being caught in the threads of the pipe or pipe cap from being crushed and subject to friction, which might ignite the powder, causing an explosion during manufacture. An assembled bomb is shown in fig. 4.42

(Ill. 4.42)

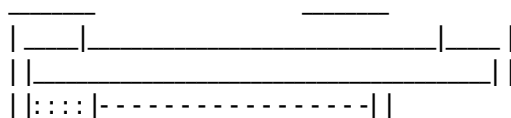



(Ill. 4.42.1 #2)

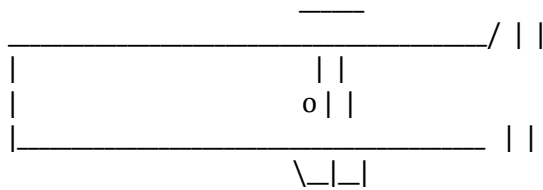

fig. 2 pipe with one end flattened and folded up (top view)

(Ill. 4.42.1 #3)

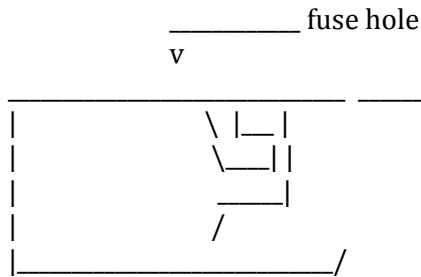

fig. 3 pipe with flattened and folded end (side view)

#### 4.42.2 CARBON DIOXIDE "Pellet Gun" or Seltzer cartridges.

A CO2 cartridge from a B.B gun is another excellent container for a low-order explosive. It has one minor disadvantage: it is time consuming to fill. But this can be rectified by widening the opening of the cartridge with a pointed tool. Then, all that would have to be done is to fill the CO2 cartridge with any low-order explosive, or any of the fast burning fuel-oxidizer mixtures, and insert a fuse. These devices are commonly called "crater makers".

From personal experience, I have found that a CO2 cartridge is easiest to fill if you take a piece of paper and tape it around the opening to form a sort of funnel:

(Ill 4.42.2)

A full cartridge can also be

fun- @ It doesn't seem to be necessary to seal the hole, but if you must do so, Epoxy and electrical tape work quite well.

a lite fire and it will CONDENSATION may form inside a recently used explode, and bottle- if you must use one right after emptying the CO2 may it, heat it in a warm oven to dry it out. extinguish the flames.

A CO2 cartridge also works well as a container for a thermite incendiary device, but it must be modified. The opening in the end must be widened, so

that the ignition mixture, such as powdered magnesium, does not explode. The fuse will ignite the powdered magnesium, which, in turn, would ignite the thermitite .

#### 4.42.3 PRIMED EXPLOSIVE CASINGS

The previously mentioned designs for explosive devices are fine for low-order explosives, but are unsuitable for high-order explosives, since the latter requires a shockwave to be detonated. A design employing a smaller low-order explosive device inside a larger device containing a high-order explosive would probably be used.

(Ill. 4.42.3)

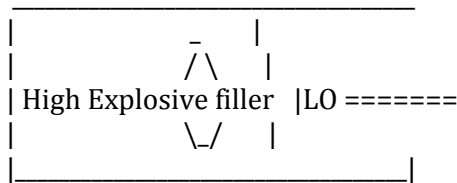

If the large high explosive container is small, such as a CO2 cartridge, then a segment of a hollow radio antenna can be made into a low-order pipe bomb, which can be fitted with a fuse, and inserted into the CO2 cartridge.

#### 4.43 GLASS CONTAINERS

Glass containers can be suitable for low-order explosives, but there are problems with them. First, a glass container can be broken relatively easily compared to metal or plastic containers. Secondly, in the not-too-unlikely event of an "accident", the person making the device would probably be seriously injured, even if the device was small. A bomb made out of a sample perfume bottle-sized container exploded in the hands of one boy, and he still has pieces of glass in his hand. He is also missing the final segment of his ring finger, which was cut off by a sharp piece of flying glass...

Nonetheless, glass containers such as perfume bottles can be used by a demented individual, since such a device would not be detected by metal detectors in an airport or other public place. All that need be done is fill the container, and drill a hole in the plastic cap that the fuse fits tightly in, and screw the cap-fuse assembly on.

(Ill. 4.43)

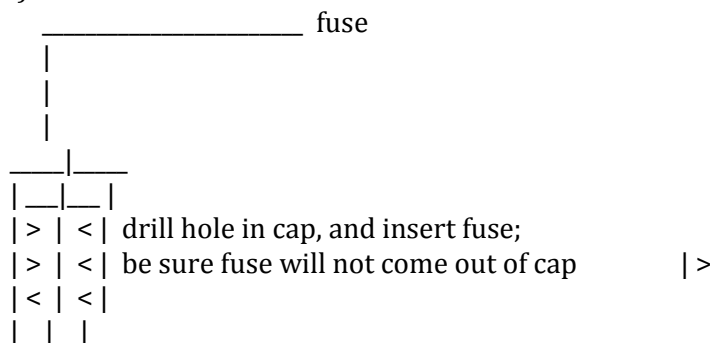

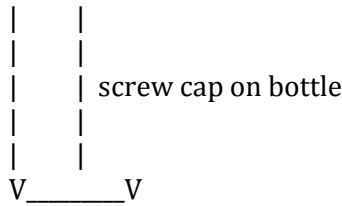

Large explosive devices made from glass containers are not practical, since glass is not an exceptionally strong container. Much of the explosive that is used to fill the container is wasted if the container is much larger than a 16 oz. soda bottle. Also, glass containers are usually unsuitable for high explosive devices, since a glass container would probably not withstand the explosion of the initiator; it would shatter before the high explosive was able to detonate.

#### 4.44 PLASTIC CONTAINERS

Plastic containers are perhaps the best containers for explosives, since they can be any size or shape, and are not fragile like glass. Plastic piping can be bought at hardware or plumbing stores, and a device much like the ones used for metal containers can be made. The high-order version works well with plastic piping. If the entire device is made out of plastic, it is not detectable by metal detectors. Plastic containers can usually be shaped by heating the container, and bending it at the appropriate place. They can be glued closed with epoxy or other cement for plastics. Epoxy alone can be used as an endcap, if a wad of tissue paper is placed in the piping. Epoxy with a drying agent works best in this type of device.

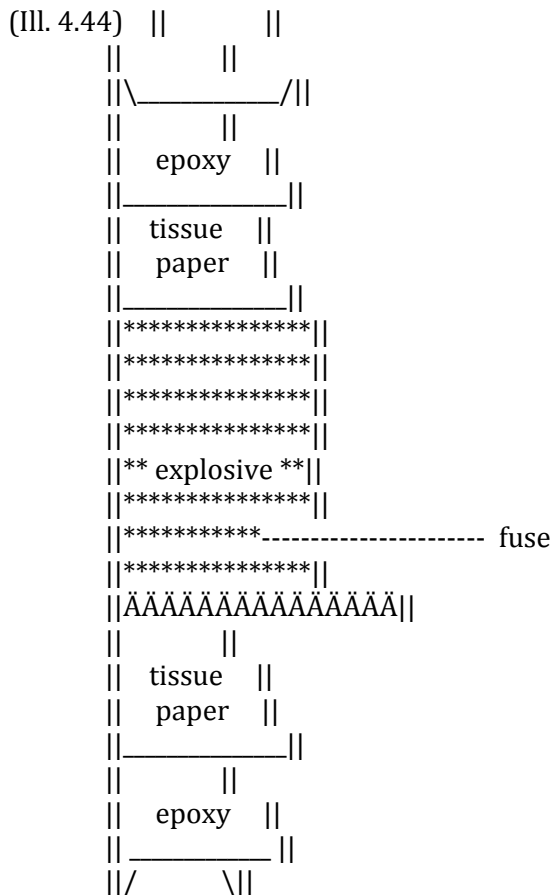

||        ||  
||        ||

One end must be made first, and be allowed to dry completely before the device can be filled with powder and fused. Then, with another piece of tissue paper, pack the powder tightly, and cover it with plenty of epoxy. PVC pipe works well for this type of device, but it cannot be used if the pipe had an inside diameter greater than 3/4 of an inch. Other plastic putties can be used in this type of device, but epoxy with a drying agent works best.

In my experience, epoxy plugs work well, but epoxy is somewhat expensive. One alternative is auto body filler, a grey paste which, when mixed with hardener, forms into a rock-like mass which is stronger than most epoxy. The only drawback is the body filler generates quite a bit of heat as it hardens, which might be enough to set off a overly sensitive explosive. One benefit of body filler is that it will hold it's shape quite well, and is ideal for forming rocket nozzles and entire bomb casings.

#### 4.44.1 FILM CANISTERS (By Bill)

For a relatively low shrapnel explosion, I suggest pouring it into an empty 35mm film cannister. Poke a hole in the plastic lid for a fuse. These goodies make an explosion audible a mile away easily.

- 1) Poke the hole before putting the flash powder into the cannister.
- 2) Don't get any powder on the lip of the cannister.
- 3) Only use a very small quantity and work your way up to the desired result.
- 4) Do not pack the powder, it works best loose.
- 5) Do not grind or rub the mixture - it is friction sensitive.
- 6) Use a long fuse.

Bill

#### 4.5 ADVANCED USES FOR EXPLOSIVES

The techniques presented here are those that could be used by a person who had some degree of knowledge of the use of explosives. Some of this information comes from demolitions books, or from military handbooks. Advanced uses for explosives usually involved shaped charges, or utilize a minimum amount of explosive to do a maximum amount of damage. They almost always involve high- order explosives.

##### 4.51 SHAPED CHARGES

A shaped charge is an explosive device that, upon detonation, directs the explosive force of detonation at a small target area. This process can be used to breach the strongest armor, since forces of literally millions of pounds of pressure per square inch can be generated. Shaped charges employ high-order explosives, and usually electric ignition systems. **KEEP IN MIND THAT ALL EXPLOSIVES ARE DANGEROUS, AND SHOULD NEVER BE MADE OR USED!!**

An example of a shaped charge is shown below.

(Ill. 4.51)

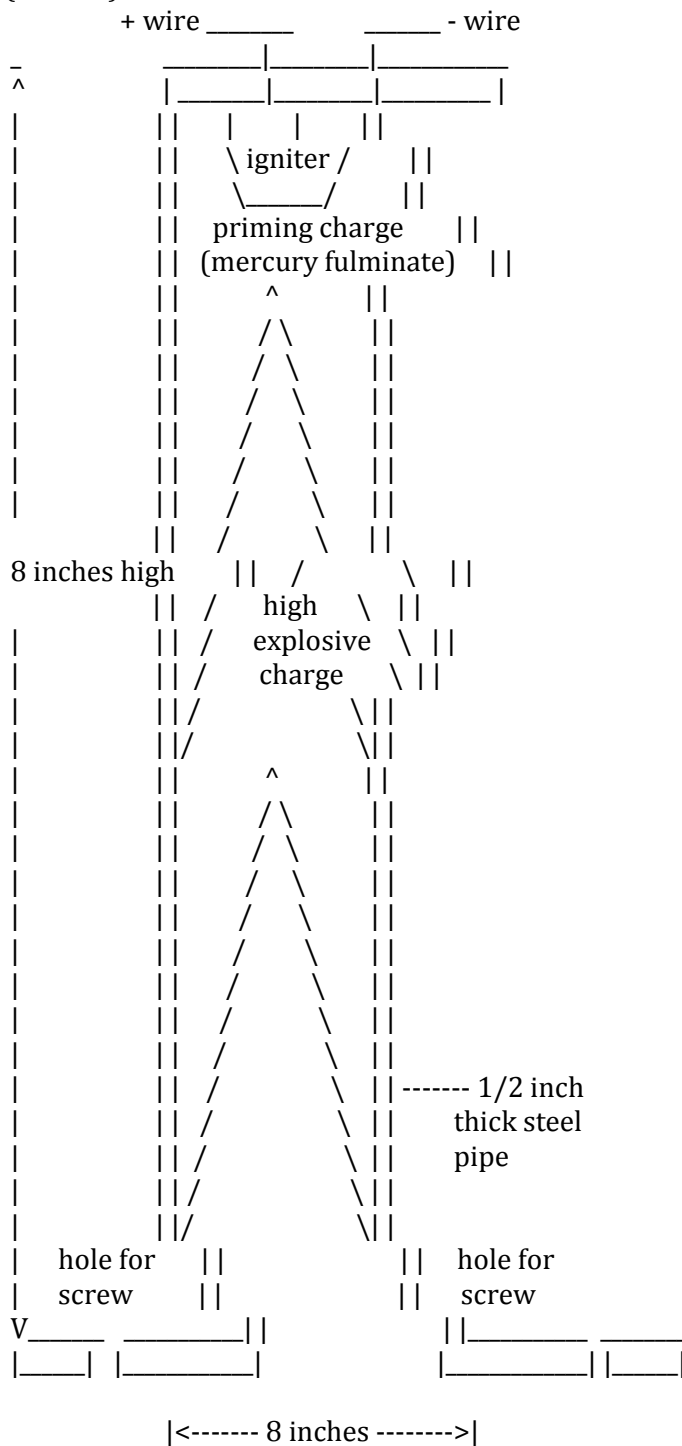

If a device such as this is screwed to a safe, for example, it would direct most of the explosive force at a point about 1 inch away from the opening of the pipe. The basis for shaped charges is a cone-shaped opening in the explosive material. This cone should have an angle of 45 degrees. A device such as this one could also be attached to a metal surface with a powerful electromagnet.

#### 4.52 TUBE EXPLOSIVES

A variation on shaped charges, tube explosives can be used in ways that shaped charges cannot. If a piece of 1/2 inch plastic tubing was filled with a sensitive high explosive like R.D.X., and prepared as the plastic explosive container in section 4.44, a different sort of shaped charge could be produced; a charge that directs explosive force in a circular manner. This type of explosive could be wrapped around a column, or a doorknob, or a telephone pole. The explosion would be directed in and out, and most likely destroy whatever it was wrapped around. In an unbent state, a tube explosive would look like this:

(Ill. 4.52)

```
||\___/|| | |
|| epoxy||
||-----||
||tissue||
|| paper||
||_____|
||*****|
||*****|
||*****|
|| RDX  ||
||*___*||
||* |s|*||
||* |q|*||
||* |u|*||
||* |i|*||
||* |b|*||
||* |b|*||
||*|_|*||
||_|_|||
||tissue||
|| paper||
||-|-||
|| epoxy||
|| || ||
||/ || \||
|| || ||
||_____| + wire _____
|_____ - wire _____
```

When an assassin or terrorist wishes to use a tube bomb, he must wrap it around whatever thing he wishes to destroy, and epoxy the ends of the tube bomb together. After it dries, he/she can connect wires to the squib wires, and detonate the bomb, with any method of electric detonation.

#### 4.53 ATOMIZED PARTICLE EXPLOSIONS

If a highly flammable substance is atomized, or, divided into very small particles, and large amounts of it is burned in a confined area, an explosion

similar to that occurring in the cylinder of an automobile is produced. The tiny droplets of gasoline burn in the air, and the hot gasses expand rapidly, pushing the cylinder up. Similarly, if a gallon of gasoline was atomized and ignited in a building, it is very possible that the expanding gasses would push the walls of the building down. This phenomenon is called an atomized particle explosion.

If a person can effectively atomize a large amount of a highly flammable substance and ignite it, he could bring down a large building, bridge, or other structure. Atomizing a large amount of gasoline, for example, can be extremely difficult, unless one has the aid of a high explosive. If a gallon jug of gasoline was placed directly over a high explosive charge, and the charge was detonated, the gasoline would instantly be atomized and ignited. If this occurred in a building, for example, an atomized particle explosion would surely occur. Only a small amount of high explosive would be necessary to accomplish this feat, about 1/2 a pound of T.N.T. or 1/4 a pound of R.D.X. Also, instead of gasoline, powdered aluminum could be used. It is necessary that a high explosive be used to atomize a flammable material, since a low-order explosion does not occur quickly enough to atomize or ignite the flammable material.

#### 4.54 LIGHTBULB BOMBS

An automatic reaction to walking into a dark room is to turn on the light. This can be fatal, if a lightbulb bomb has been placed in the overhead light socket. A lightbulb bomb is surprisingly easy to make. It also comes with its own initiator and electric ignition system. On some lightbulbs, the lightbulb glass can be removed from the metal base by heating the base of a lightbulb in a gas flame, such as that of a blowtorch or gas stove. This must be done carefully, since the inside of a lightbulb is a vacuum. When the glue gets hot enough, the glass bulb can be pulled off the metal base. On other bulbs, it is necessary to heat the glass directly with a blowtorch or oxy-acetylene torch. In either case, once the bulb and/or base has cooled down to room temperature or lower, the bulb can be filled with an explosive material, such as black powder. If the glass was removed from the metal base, it must be glued back on to the base with epoxy. If a hole was put in the bulb, a piece of duct tape is sufficient to hold the explosive in the bulb. Then, after making sure that the socket has no power by checking with a working lightbulb, all that need be done is to screw the lightbulb bomb into the socket. Such a device has been used by terrorists or assassins with much success, since few people would search the room for a bomb without first turning on the light.

#### 4.55 BOOK BOMBS

Concealing a bomb can be extremely difficult in a day and age where perpetrators of violence run wild. Bags and briefcases are often searched by authorities whenever one enters a place where an individual might intend to set off a bomb. One approach to disguising a bomb is to build what is called a book bomb; an explosive device that is entirely contained inside of a book.

Usually, a relatively large book is required, and the book must be of the

hardback variety to hide any protrusions of a bomb. Dictionaries, law books, large textbooks, and other such books work well. When an individual makes a bookbomb, he/she must choose a type of book that is appropriate for the place where the book bomb will be placed. The actual construction of a book bomb can be done by anyone who possesses an electric drill and a coping saw. First, all of the pages of the book must be glued together. By pouring an entire container of water-soluble glue into a large bucket, and filling the bucket with boiling water, a glue-water solution can be made that will hold all of the book's pages together tightly. After the glue-water solution has cooled to a bearable temperature, and the solution has been stirred well, the pages of the book must be immersed in the glue-water solution, and each page must be thoroughly soaked.

It is extremely important that the covers of the book do not get stuck to the pages of the book while the pages are drying. Suspending the book by both covers and clamping the pages together in a vise works best. When the pages dry, after about three days to a week, a hole must be drilled into the now rigid pages, and they should drill out much like wood. Then, by inserting the coping saw blade through the pages and sawing out a rectangle from the middle of the book, the individual will be left with a shell of the book's pages. The pages, when drilled out, should look like this:

(Ill. 4.55)

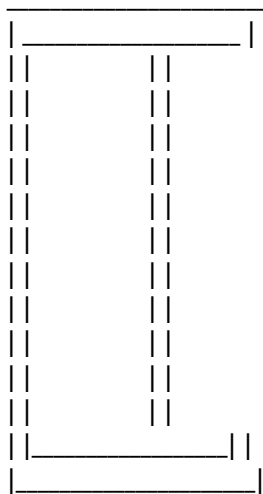

(book covers omitted)

This rectangle must be securely glued to the back cover of the book. After building his/her bomb, which usually is of the timer or radio controlled variety, the bomber places it inside the book. The bomb itself, and whatever timer or detonator is used, should be packed in foam to prevent it from rolling or shifting about. Finally, after the timer is set, or the radio control has been turned on, the front cover is glued closed, and the bomb is taken to its destination.

#### 4.56 PHONE BOMBS

The phone bomb is an explosive device that has been used in the past to kill or injure a specific individual. The basic idea is simple: when the

person answers the phone, the bomb explodes. If a small but powerful high explosive device with a squib was placed in the phone receiver, when the current flowed through the receiver, the squib would explode, detonating the high explosive in the person's hand. Nasty. All that has to be done is acquire a squib, and tape the receiver switch down.

Unscrew the mouthpiece cover, and remove the speaker, and connect the squib's leads where it was. Place a high explosive putty, such as C-1 (see section 3.31) in the receiver, and screw the cover on, making sure that the squib is surrounded by the C-1. Hang the phone up, and leave the tape in place.

When the individual to whom the phone belongs attempts to answer the phone, he will notice the tape, and remove it. This will allow current to flow through the squib. Note that the device will not explode by merely making a phone call; the owner of the phone must lift up the receiver, and remove the tape. It is highly probable that the phone will be by his/her ear when the device explodes...

#### 4.56.1 IMPROVED PHONE BOMB (from Dave R.)

The above seems overly complicated to me... it would be better to rig the device as follows:

\_\_\_\_\_ FIRST UNPLUG THE PHONE FROM THE WALL  
/|-----|\ Wire the detonator IN LINE with the wires going to the earpiece,  
~ | | ~ (may need to wire it with a relay so the detonator can receive  
@@@@@@@@ the full line power, not just the audio power to the earpiece)  
@@@@@@@@  
@@@@@@@@ Pack C4 into the phone body (NOT the handset) and plug it back  
in. When they pick up the phone, power will flow through the  
circuit to the detonator....

### 5.0 SPECIAL AMMUNITION FOR PROJECTILE WEAPONS

Explosive and/or poisoned ammunition is an important part of a social deviant's arsenal. Such ammunition gives the user a distinct advantage over individual who use normal ammunition, since a grazing hit is good enough to kill. Special ammunition can be made for many types of weapons, from crossbows to shotguns.

#### 5.1 SPECIAL AMMUNITION FOR PRIMITIVE WEAPONS

For the purposes of this publication, we will call any weapon primitive that does not employ burning gunpowder to propel a projectile forward. This means blowguns, bows and crossbows, and wristrockets.

##### 5.11 BOW AND CROSSBOW AMMUNITION

Bows and crossbows both fire arrows or bolts as ammunition. It is extremely simple to poison an arrow or bolt, but it is a more difficult matter to produce explosive arrows or bolts. If, however, one can acquire aluminum

piping that is the same diameter of an arrow or crossbow bolt, the entire segment of piping can be converted into an explosive device that detonates upon impact, or with a fuse.

All that need be done is find an aluminum tube of the right length and diameter, and plug the back end with tissue paper and epoxy. Fill the tube with any type of low-order explosive or sensitive high-order explosive up to about 1/2 an inch from the top.

Cut a slot in the piece of tubing, and carefully squeeze the top of the tube into a round point, making sure to leave a small hole. Place a no. 11 percussion cap over the hole, and secure it with super glue or epoxy.

Finally, wrap the end of the device with electrical or duct tape, and make fins out of tape. Or, fins can be bought at a sporting goods store, and glued to the shaft. The finished product should look like:

(Ill. 5.11)

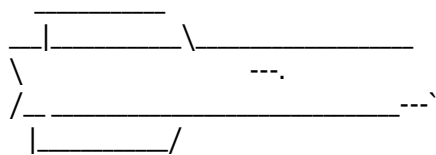

When the arrow or bolt strikes a hard surface, the percussion cap explodes, igniting or detonating the explosive.

## 5.12 SPECIAL AMMUNITION FOR BLOWGUNS

The blowgun is an interesting weapon which has several advantages. A blowgun can be extremely accurate, concealable, and deliver an explosive or poisoned projectile. The manufacture of an explosive dart or projectile is not difficult. To acquire a blowgun, please contact the editor at one of the addresses given in the introduction.

Perhaps the most simple design for such involves the use of a pill capsule, such as the kind that are taken for headaches or allergies. Empty gelatin pill capsules can be purchased from most health-food stores. Next, the capsule would be filled with an impact-sensitive explosive, such as mercury fulminate. An additional high explosive charge could be placed behind the impact sensitive explosive, if one of the larger capsules were used.

Finally, the explosive capsule would be reglued back together, and a tassel or cotton would be glued to the end containing the high explosive, to insure that the impact-detonating explosive struck the target first.

Such a device would probably be about 3/4 of an inch long, not including the tassel or cotton, and look something like this:

(Ill. 5.12)

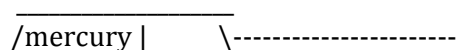

(fulminate| R.D.X. )----- } tassels  
 \\_\_\_\_\_|\_\_\_\_\_/-----

Care must be taken- if a powerful dart went off in the blowgun, you could easily blow the back of your head off.

### 5.13 SPECIAL AMMUNITION FOR WRISTROCKETS AND SLINGSHOTS

A modern wristrocket is a formidable weapon. It can throw a shooter marble about 500 ft. with reasonable accuracy. Inside of 200 ft., it could well be lethal to a man or animal, if it struck in a vital area. Because of the relatively large sized projectile that can be used in a wristrocket, the wristrocket can be adapted to throw relatively powerful explosive projectiles.

A small segment of aluminum pipe could be made into an impact-detonating device by filling it with an impact-sensitive explosive material.

Also, such a pipe could be filled with a low-order explosive, and fitted with a fuse, which would be lit before the device was shot. One would have to make sure that the fuse was of sufficient length to insure that the device did not explode before it reached its intended target.

Finally, .22 caliber caps, such as the kind that are used in .22 caliber blank guns, make excellent exploding ammunition for wristrockets, but they must be used at a relatively close range, because of their light weight.

### 5.2 SPECIAL AMMUNITION FOR FIREARMS

When special ammunition is used in combination with the power and rapidity of modern firearms, it becomes very easy to take on a small army with a single weapon. It is possible to buy explosive ammunition, but that can be difficult to do. Such ammunition can also be manufactured in the home. There is, however, a risk involved with modifying any ammunition. If the ammunition is modified incorrectly, in such a way that it makes the bullet even the slightest bit wider, an explosion in the barrel of the weapon will occur. For this reason, **NOBODY SHOULD EVER ATTEMPT TO MANUFACTURE SUCH AMMUNITION.**

#### 5.21 SPECIAL AMMUNITION FOR HANDGUNS

If an individual wished to produce explosive ammunition for his/her handgun, he/she could do it, provided that the person had an impact-sensitive explosive and a few simple tools. One would first purchase all lead bullets, and then make or acquire an impact-detonating explosive. By drilling a hole in a lead bullet with a drill, a space could be created for the placement of an explosive. After filling the hole with an explosive, it would be sealed in the bullet with a drop of hot wax from a candle. A diagram of a completed exploding bullet is shown below.

(Ill. 5.21)

\_o\_ ----- drop of wax

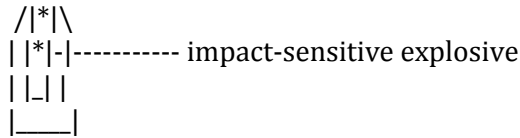

This hollow space design also works for putting poison in bullets.

In many spy thrillers, an assassin is depicted as manufacturing "exploding bullets" by placing a drop of mercury in the nose of a bullet. Through experimentation it has been found that this will not work. Mercury reacts with lead to form an inert silvery compound.

## 5.22 SPECIAL AMMUNITION FOR SHOTGUNS

Because of their large bore and high power, it is possible to create some extremely powerful special ammunition for use in shotguns. If a shotgun shell is opened at the top, and the shot removed, the shell can be re-closed. Then, if one can find a very smooth, lightweight wooden dowel that is close to the bore width of the shotgun, a person can make several types of shotgun-launched weapons.

Insert the dowel in the barrel of the shotgun with the shell without the shot in the firing chamber. Mark the dowel about six inches away from the end of the barrel, and remove it from the barrel.

Next, decide what type of explosive or incendiary device is to be used. This device can be a chemical fire bottle (sect. 3.43), a pipe bomb (sect 4.42), or a thermite bomb (sect 3.41 and 4.42). After the device is made, it must be securely attached to the dowel. When this is done, place the dowel back in the shotgun. The bomb or incendiary device should be on the end of the dowel.

Make sure that the device has a long enough fuse, light the fuse, and fire the shotgun. If the projectile is not too heavy, ranges of up to 300 ft are possible. A diagram of a shotgun projectile is shown below:

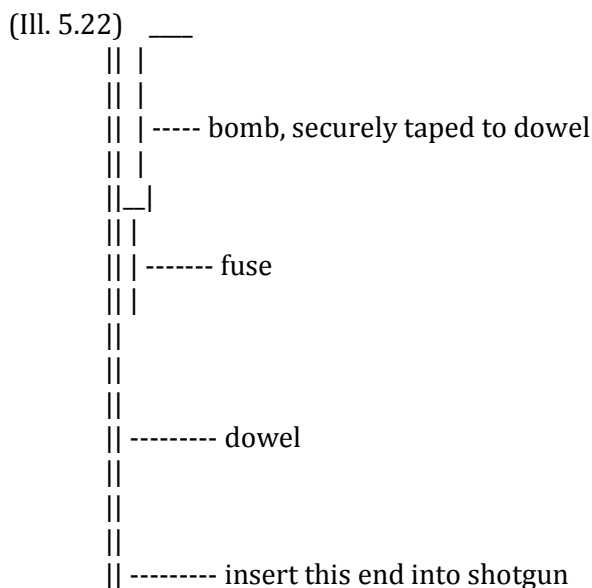

||  
||

Special "grenade-launcher blanks" should be used- use of regular blank ammunition may cause the device to land perilously close to the user.

### 5.3 SPECIAL AMMUNITION FOR COMPRESSED AIR/GAS WEAPONS

This section deals with the manufacture of special ammunition for compressed air or compressed gas weapons, such as pump B.B guns, CO2 B.B guns, and .22 cal pellet guns. These weapons, although usually thought of as kids toys, can be made into rather dangerous weapons.

#### 5.31 SPECIAL AMMUNITION FOR B.B GUNS

A B.B gun, for this manuscript, will be considered any type of rifle or pistol that uses compressed air or CO2 gas to fire a projectile with a caliber of .177, either B.B, or lead pellet. Such guns can have almost as high a muzzle velocity as a bullet-firing rifle. Because of the speed at which a .177 caliber projectile flies, an impact detonating projectile can easily be made that has a caliber of .177.

Most ammunition for guns of greater than .22 caliber use primers to ignite the powder in the bullet. These primers can be bought at gun stores, since many people like to reload their own bullets. Such primers detonate when struck by the firing pin of a gun. They will also detonate if they are thrown at a hard surface at a great speed.

Usually, they will also fit in the barrel of a .177 caliber gun. If they are inserted flat end first, they will detonate when the gun is fired at a hard surface. If such a primer is attached to a piece of thin metal tubing, such as that used in an antenna, the tube can be filled with an explosive, be sealed, and fired from a B.B gun. A diagram of such a projectile appears below:

(Ill. 5.31)

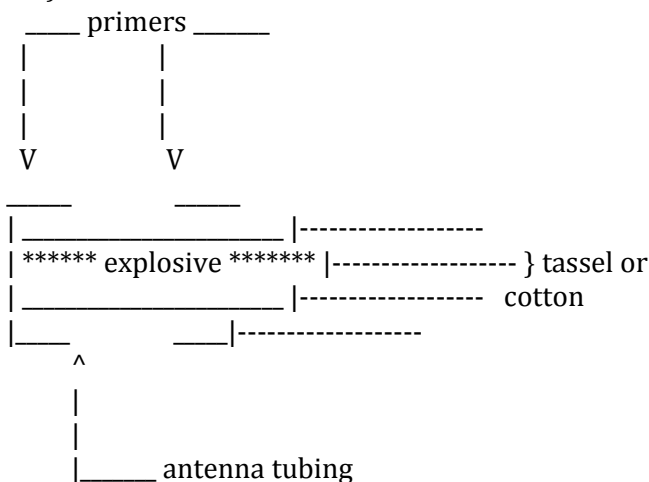

The front primer is attached to the tubing with a drop of super glue. The tubing is then filled with an explosive, and the rear primer is glued on.

Finally, a tassel, or a small piece of cotton is glued to the rear primer, to insure that the projectile strikes on the front primer. The entire projectile should be about 3/4 of an inch long.

### 5.32 SPECIAL AMMUNITION FOR .22 CALIBER PELLET GUNS

A .22 caliber pellet gun usually is equivalent to a .22 cal rifle, at close ranges. Because of this, relatively large explosive projectiles can be adapted for use with .22 caliber air rifles. A design similar to that used in section 5.12 is suitable, since some capsules are about .22 caliber or smaller. Or, a design similar to that in section 5.31 could be used, only one would have to purchase black powder percussion caps, instead of ammunition primers, since there are percussion caps that are about .22 caliber. A #11 cap is too small, but anything larger will do nicely.

## 6.0 ROCKETS AND CANNONS

Rockets and cannon are generally thought of as heavy artillery. Perpetrators of violence do not usually employ such devices, because they are difficult or impossible to acquire. They are not, however, impossible to make. Any individual who can make or buy black powder or pyrodex can make such things. A terrorist with a cannon or large rocket is, indeed, something to fear.

### 6.1 ROCKETS

Rockets were first developed by the Chinese several hundred years before the myth of christ began. They were used for entertainment, in the form of fireworks. They were not usually used for military purposes because they were inaccurate, expensive, and unpredictable. In modern times, however, rockets are used constantly by the military, since they are cheap, reliable, and have no recoil. Perpetrators of violence, fortunately, cannot obtain military rockets, but they can make or buy rocket engines. Model rocketry is a popular hobby of the space age, and to launch a rocket, an engine is required. Estes, a subsidiary of Damon, is the leading manufacturer of model rockets and rocket engines. Their most powerful engine, the "D" engine, can develop almost 12 lbs. of thrust; enough to send a relatively large explosive charge a significant distance. Other companies, such as Centuri, produce even larger rocket engines, which develop up to 30 lbs. of thrust. These model rocket engines are quite reliable, and are designed to be fired electrically. Most model rocket engines have three basic sections. The diagram below will help explain them.

(Ill. 6.1)

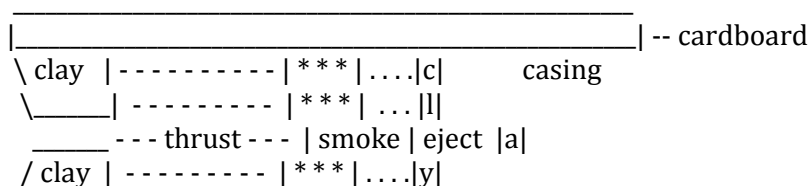

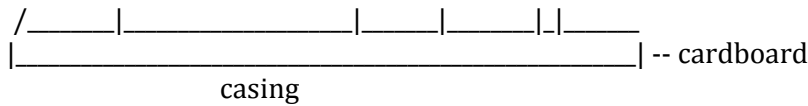

The clay nozzle is where the igniter is inserted. When the area labeled "thrust" is ignited, the "thrust" material, usually a large single grain of a propellant such as black powder or pyrodex, burns, forcing large volumes of hot, rapidly expanding gasses out the narrow nozzle, pushing the rocket forward.

After the material has been consumed, the smoke section of the engine is ignited. It is usually a slow-burning material, similar to black powder that has had various compounds added to it to produce visible smoke, usually black, white, or yellow in color. This section exists so that the rocket will be seen when it reaches its maximum altitude, or apogee.

When it is burned up, it ignites the ejection charge, labeled "eject". The ejection charge is finely powdered black powder. It burns very rapidly, exploding, in effect. The explosion of the ejection charge pushes out the parachute of the model rocket. It could also be used to ignite the fuse of a bomb...

Rocket engines have their own peculiar labeling system. Typical engine labels are: 1/4A-2T, 1/2A-3T, A8-3, B6-4, C6-7, and D12-5. The letter is an indicator of the power of an engine. "B" engines are twice as powerful as "A" engines, and "C" engines are twice as powerful as "B" engines, and so on. The number following the letter is the approximate thrust of the engine, in pounds. the final number and letter is the time delay, from the time that the thrust period of engine burn ends until the ejection charge fires; "3T" indicates a 3 second delay.

NOTE: an extremely effective rocket propellant can be made by mixing aluminum dust with ammonium perchlorate and a very small amount of iron oxide. The mixture is bound together by an epoxy.

### 6.11 BASIC ROCKET BOMB

A rocket bomb is simply what the name implies: a bomb that is delivered to its target by means of a rocket. Most people who would make such a device would use a model rocket engine to power the device. By cutting fins from balsa wood and gluing them to a large rocket engine, such as the Estes "C" engine, a basic rocket could be constructed. Then, by attaching a "crater maker", or CO2 cartridge bomb to the rocket, a bomb would be added. To insure that the fuse of the "crater maker" (see sect. 4.42) ignited, the clay over the ejection charge of the engine should be scraped off with a plastic tool. The fuse of the bomb should be touching the ejection charge, as shown below.

(Ill. 6.11 #1)

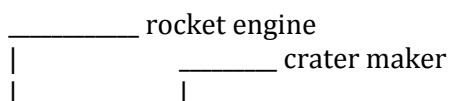

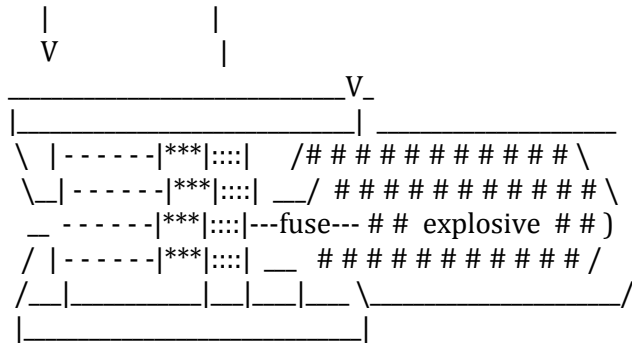

thrust> -----  
 smoke> \*\*\*  
 ejection charge> :::

Duct tape is the best way to attach the crater maker to the rocket engine. Note in the diagram the absence of the clay over the ejection charge. Many different types of explosive payloads can be attached to the rocket, such as a high explosive, an incendiary device, or a chemical fire bottle.

Either four or three fins must be glued to the rocket engine to insure that the rocket flies straight. The fins should look like the following diagram:

(Ill. 6.11 #2)

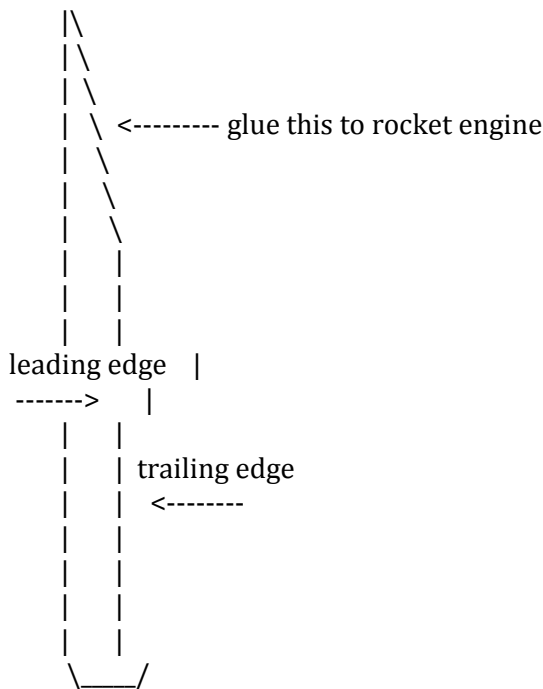

The leading edge and trailing edge should be sanded with sandpaper so that they are rounded. This will help make the rocket fly straight. A two inch long section of a plastic straw can be attached to the rocket to launch it from. A clothes hanger can be cut and made into a launch rod. The segment of a plastic straw should be glued to the rocket engine adjacent to one of the fins of the rocket. A front view of a completed rocket bomb is shown below.

(Ill. 6.11 #3)

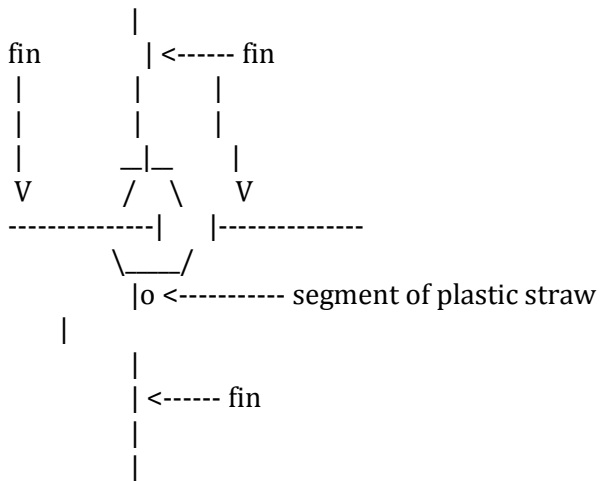

By cutting a coat hanger at the indicated arrows, and bending it, a launch rod can be made. After a fuse is inserted in the engine, the rocket is simply slid down the launch rod, which is put through the segment of plastic straw. The rocket should slide easily along a coathanger, such as the one illustrated on the following page:

(Ill. 6.11 #4)

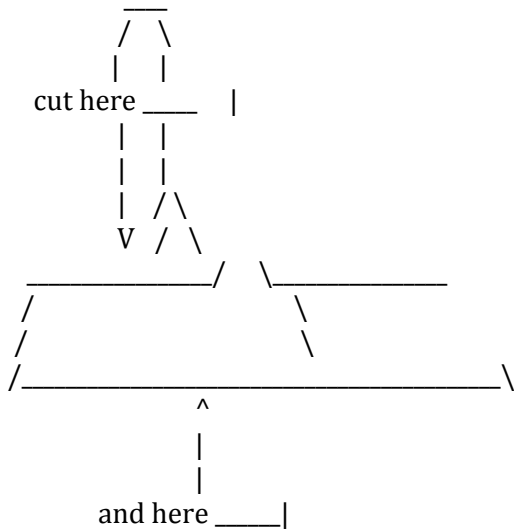

Bend wire to this shape:

(Ill. 6.11 #5)

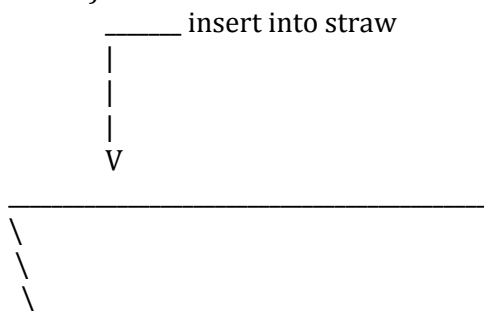

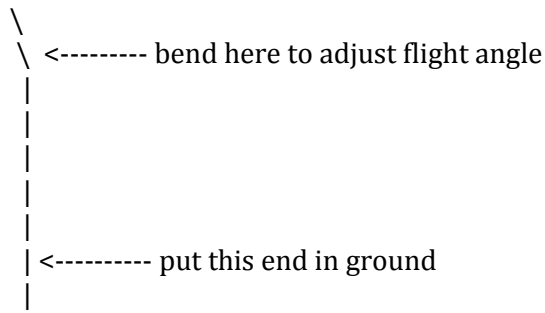

## 6.12 LONG RANGE ROCKET BOMB

Long range rockets can be made by using multi-stage rockets. Model rocket engines with an "0" for a time delay are designed for use in multi-stage rockets. An engine such as the D12-0 is an excellent example of such an engine. Immediately after the thrust period is over, the ejection charge explodes. If another engine is placed directly against the back of an "0" engine, the explosion of the ejection charge will send hot gasses and burning particles into the nozzle of the engine above it, and ignite the thrust section. This will push the used "0" engine off of the rocket, causing an overall loss of weight.

The main advantage of a multi-stage rocket is that it loses weight as travels, and it gains velocity. A multi-stage rocket must be designed somewhat differently than a single stage rocket, since, in order for a rocket to fly straight, its center of gravity must be ahead of its center of drag. This is accomplished by adding weight to the front of the rocket, or by moving the center of drag back by putting fins on the rocket that are well behind the rocket. A diagram of a multi-stage rocket appears on the following page:

(Ill. 6.12)

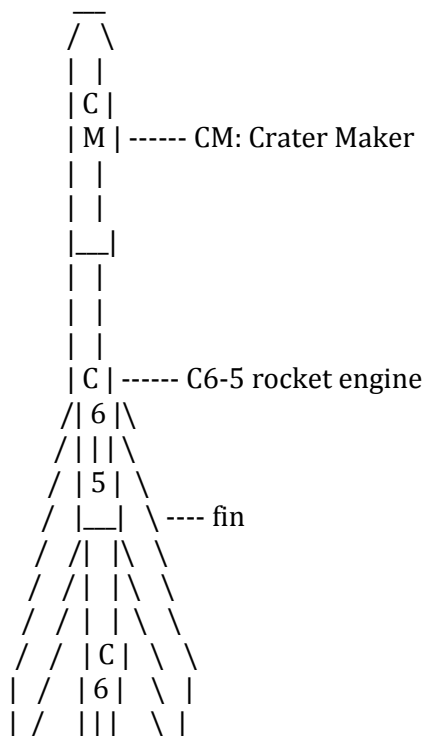

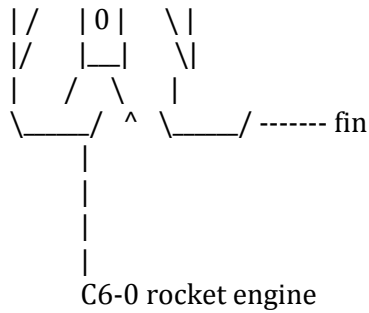

The fuse is put in the bottom engine.

Two, three, or even four stages can be added to a rocket bomb to give it a longer range. It is important, however, that for each additional stage, the fin area gets larger.

## 6.2 CANNON

The cannon is a piece of artillery that has been in use since the 11th century. It is not unlike a musket, in that it is filled with powder, loaded, and fired. Cannons of this sort must also be cleaned after each shot, otherwise, the projectile may jam in the barrel when it is fired, causing the barrel to explode. A sociopath could build a cannon without too much trouble, if he/she had a small sum of money, and some patience.

### 6.21 BASIC PIPE CANNON

A simple cannon can be made from a thick pipe by almost anyone. The only difficult part is finding a pipe that is extremely smooth on its interior. This is absolutely necessary; otherwise, the projectile may jam. Copper or aluminum piping is usually smooth enough, but it must also be extremely thick to withstand the pressure developed by the expanding hot gasses in a cannon.

If one uses a projectile such as a CO2 cartridge, since such a projectile can be made to explode, a pipe that is about 1.5 - 2 feet long is ideal. Such a pipe MUST have walls that are at least 1/3 to 1/2 an inch thick, and be very smooth on the interior. If possible, screw an endplug into the pipe. Otherwise, the pipe must be crimped and folded closed, without cracking or tearing the pipe. A small hole is drilled in the back of the pipe near the crimp or endplug. Then, all that need be done is fill the pipe with about two teaspoons of grade blackpowder or pyrodex, insert a fuse, pack it lightly by ramming a wad of tissue paper down the barrel, and drop in a CO2 cartridge. Brace the cannon securely against a strong structure, light the fuse, and run. If the person is lucky, he will not have overcharged the cannon, and he will not be hit by pieces of exploding barrel. Such a cannon would look like this:

(Ill. 6.21 #1)

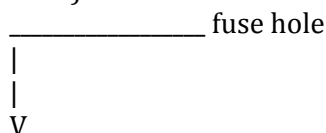



Here is a cross section:

(Ill. 6.23)

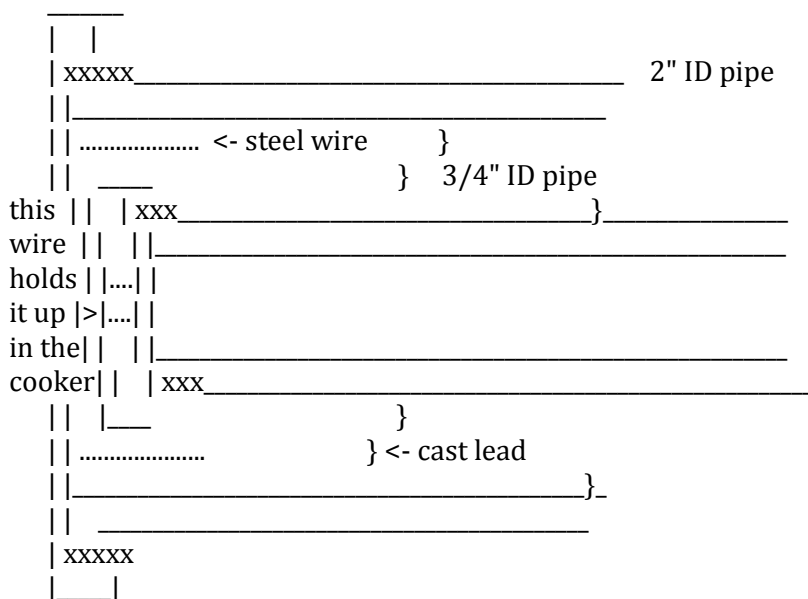

We dug into the side of a sand pile and built a chimney out of firebrick. Then we stood the assembled pipe and wire on end in the chimney, sitting on some bricks. We then had a blowtorch heating up the chimney, so that the pipe was red hot. Then we poured molten lead into the space between the pipes. If the caps aren't screwed on real tight, some of the lead will leak out. If that happens, turn off the blowtorch and the pipe will cool enough and the lead will stiffen and stop the leak.

We used homemade and commercial black powder, and slow smokeless shotgun powder in this thing. After hundreds of shots we cut it up and there was no evidence of cracks or swelling of the inner pipe.

Loren

## 7.0 PYROTECHNICA ERRATA

There are many other types of pyrotechnics that a perpetrator of violence might employ. Smoke bombs can be purchased in magic stores, and large military smoke bombs can be bought through ads in gun and military magazines. Also, fireworks can also be used as weapons of terror. A large aerial display rocket would cause many injuries if it were to be fired so that it landed on the ground near a crowd of people. Even the "harmless" pull-string fireworks, which consists of a sort of firecracker that explodes when the strings running through it are pulled, could be placed inside a large charge of a sensitive high explosive. Tear gas is another material that might well be useful to the sociopath, and such a material could be instantly disseminated over a large crowd by means of a rocket-bomb, with nasty effects.

## 7.1 SMOKE BOMBS

One type of pyrotechnic device that might be employed by a terrorist in many ways would be a smoke bomb. Such a device could conceal the getaway route, or cause a diversion, or simply provide cover. Such a device, were it to produce enough smoke that smelled bad enough, could force the evacuation of a building, for example. Smoke bombs are not difficult to make. Although the military smoke bombs employ powdered white phosphorus or titanium compounds, such materials are usually unavailable to even the most well-equipped terrorist. Instead, he/she would have to make the smoke bomb for themselves.

Most homemade smoke bombs usually employ some type of base powder, such as black powder or pyrodex, to support combustion. The base material will burn well, and provide heat to cause the other materials in the device to burn, but not completely or cleanly. Table sugar, mixed with sulfur and a base material, produces large amounts of smoke. Sawdust, especially if it has a small amount of oil in it, and a base powder works well also. Other excellent smoke ingredients are small pieces of rubber, finely ground plastics, and many chemical mixtures. The material in road flares can be mixed with sugar and sulfur and a base powder produces much smoke. Most of the fuel-oxidizer mixtures, if the ratio is not correct, produce much smoke when added to a base powder. The list of possibilities goes on and on. The trick to a successful smoke bomb also lies in the container used. A plastic cylinder works well, and contributes to the smoke produced. The hole in the smoke bomb where the fuse enters must be large enough to allow the material to burn without causing an explosion. This is another plus for plastic containers, since they will melt and burn when the smoke material ignites, producing an opening large enough to prevent an explosion.

### 7.11 SIMPLE SMOKE (By Zaphod)

The following reaction should produce a fair amount of smoke. Since this reaction is not all that dangerous you can use larger amounts if necessary

6 pt. ZINC POWDER

1 pt. SULFUR POWDER

Insert a red hot wire into the pile, step back.

## 7.2 COLORED FLAMES

Colored flames can often be used as a signaling device for terrorists. by putting a ball of colored flame material in a rocket; the rocket, when the ejection charge fires, will send out a burning colored ball. The materials that produce the different colors of flames appear below.

COLOR	MATERIAL	USED IN
red	strontium salts (strontium nitrate)	road flares, red sparklers
green	barium salts	green sparklers

(barium nitrate)

yellow	sodium salts (sodium nitrate)	gold sparklers
blue	powdered copper old pennies	blue sparklers,
white	powdered magnesium or aluminum	firestarters, aluminum foil
purple	potassium permanganate	purple fountains, treating sewage

### 7.3 TEAR GAS

A terrorist who could make tear gas or some similar compound could use it with ease against a large number of people. Tear gas is fairly complicated to make, however, and this prevents such individuals from being able to utilize its great potential for harm. One method for its preparation is shown below.

#### EQUIPMENT FOR MAKING TEAR GAS

---

- |                             |                      |
|-----------------------------|----------------------|
| 1. ring stands (2)          | 7. clamp holder      |
| 2. alcohol burner           | 8. condenser         |
| 3. erlenmeyer flask, 300 ml | 9. rubber tubing     |
| 4. clamps (2)               | 10. collecting flask |
| 5. rubber stopper           | 11. air trap         |
| 6. glass tubing             | 12. beaker, 300 ml   |

#### MATERIALS

---

10 gms glycerine 2 gms sodium bisulfate distilled water

- 1.) In an open area, wearing a gas mask, mix 10 gms of glycerine with 2 gms of sodium bisulfate in the 300 ml erlenmeyer flask.
- 2.) Light the alcohol burner, and gently heat the flask.
- 3.) The mixture will begin to bubble and froth; these bubbles are tear gas.
- 4.) When the mixture being heated ceases to froth and generate gas, or a brown residue becomes visible in the tube, the reaction is complete. Remove the heat source, and dispose of the heated mixture, as it is corrosive.
- 5.) The material that condenses in the condenser and drips into the collecting flask is tear gas. It must be capped tightly, and stored in a safe place.

### 7.4 FIREWORKS

While fireworks cannot really be used as an effective means of terror, they do have some value as distractions or incendiaries. There are several basic types of fireworks that can be made in the home, whether for fun, profit, or nasty uses.

#### 7.41 FIRECRACKERS

A simple firecracker can be made from cardboard tubing and epoxy. The instructions are below:

- 1) Cut a small piece of cardboard tubing from the tube you are using. "Small" means anything less than 4 times the diameter of the tube.
- 2) Set the section of tubing down on a piece of wax paper, and fill it with epoxy and the drying agent to a height of 3/4 the diameter of the tubing. Allow the epoxy to dry to maximum hardness, as specified on the package.
- 3) When it is dry, put a small hole in the middle of the tube, and insert a desired length of fuse.
- 4) Fill the tube with any type of flame-sensitive explosive. Flash powder, pyrodex, black powder, potassium picrate, lead azide, nitrocellulose, or any of the fast burning fuel-oxidizer mixtures will do nicely. Fill the tube almost to the top.
- 5) Pack the explosive tightly in the tube with a wad of tissue paper and a pencil or other suitable ramrod. Be sure to leave enough space for more epoxy.
- 6) Fill the remainder of the tube with the epoxy and hardener, and allow it to dry.
- 7) For those who wish to make spectacular firecrackers, always use flash powder, mixed with a small amount of other material for colors. By crushing the material on a sparkler, and adding it to the flash powder, the explosion will be the same color as the sparkler. By adding small chunks of sparkler material, the device will throw out colored burning sparks, of the same color as the sparkler. By adding powdered iron, orange sparks will be produced. White sparks can be produced from magnesium shavings, or from small, LIGHTLY crumpled balls of aluminum foil.

Example: Suppose I wish to make a firecracker that will explode with a red flash, and throw out white sparks.

First, I would take a road flare, and finely powder the material inside it. Or, I could take a red sparkler, and finely powder it.

Then, I would mix a small amount of this material with the flash powder. (NOTE: FLASH POWDER MAY REACT WITH SOME MATERIALS THAT IT IS MIXED WITH, AND EXPLODE SPONTANEOUSLY!) I would mix it in a ratio of 9 parts flash powder to 1 part of flare or sparkler material, and add about 15 small balls of aluminum foil I would store the material in a plastic bag

overnight outside of the house, to make sure that the stuff doesn't react. Then, in the morning, I would test a small amount of it, and if it was satisfactory, I would put it in the firecracker.

- 8) If this type of firecracker is mounted on a rocket engine, professional to semi-professional displays can be produced.

#### 7.42 SKYROCKETS

An impressive home made skyrocket can easily be made in the home from model rocket engines. Estes engines are recommended.

- 1) Buy an Estes Model Rocket Engine of the desired size, remembering that the power doubles with each letter. (See sect. 6.1 for details)
- 2) Either buy a section of body tube for model rockets that exactly fits the engine, or make a tube from several thicknesses of paper and glue.
- 3) Scrape out the clay backing on the back of the engine, so that the powder is exposed. Glue the tube to the engine, so that the tube covers at least half the engine. Pour a small charge of flash powder in the tube, about 1/2 an inch.
- 4) By adding materials as detailed in the section on firecrackers, various types of effects can be produced.
- 5) By putting Jumping Jacks or bottle rockets without the stick in the tube, spectacular displays with moving fireballs or M.R.V.'s can be produced.
- 6) Finally, by mounting many home made firecrackers on the tube with the fuses in the tube, multiple colored bursts can be made.

#### 7.43 ROMAN CANDLES

Roman candles are impressive to watch. They are relatively difficult to make, compared to the other types of home-made fireworks, but they are well worth the trouble.

- 1) Buy a 1/2 inch thick model rocket body tube, and reinforce it with several layers of paper and/or masking tape. This must be done to prevent the tube from exploding. Cut the tube into about 10 inch lengths.
- 2) Put the tube on a sheet of wax paper, and seal one end with epoxy and the drying agent. About 1/2 of an inch is sufficient.
- 3) Put a hole in the tube just above the bottom layer of epoxy, and insert a desired length of water proof fuse. Make sure that the fuse fits tightly.
- 4) Pour about 1 inch of pyrodex or gunpowder down the open end of the tube.
- 5) Make a ball by powdering about two 6 inch sparklers of the desired color. Mix this powder with a small amount of flash powder and a small amount of



PORT HURON, MICHIGAN 48060

CROSSMAN AIR GUNS                      AIR GUNS  
P.O. BOX 22927  
ROCHESTER, NEW YORK  
14692

R. ALLEN                                      PROFESSIONAL FIREWORKS CONSTRUCTION  
P.O. BOX 146                                  BOOKS & FORMULAS  
WILLOW GROVE, PA 19090

MJ DISTRIBUTING                          FIREWORKS FORMULAS  
P.O. BOX 10585  
YAKIMA, WA 98909

EXECUTIVE PROTECTION PRODUCTS INC.    TEAR GAS GRENADES,  
316 CALIFORNIA AVE.                      PROTECTION DEVICES  
RENO, NEVADA  
89509

COMPANY NAME AND ADDRESS              WHAT COMPANY SELLS  
AAAAAAAAAAAAAAAAAAAAAAAAAAAA      AAAAAAAAAAAAAAAAAAAAAA  
BADGER FIREWORKS CO. INC.              CLASS "B" AND "C" FIREWORKS BOX 1451  
JANESVILLE, WISCONSIN  
53547

NEW ENGLAND FIREWORKS CO. INC.      CLASS "C" FIREWORKS P.O. BOX 3504  
STAMFORD, CONNECTICUT  
06095

RAINBOW TRAIL                              CLASS "C" FIREWORKS BOX 581  
EDGEMONT, PENNSYLVANIA 19028

STONINGTON FIREWORKS INC.              CLASS "C" AND "B" FIREWORKS 4010 NEW  
WILSEY BAY U.25 ROAD  
RAPID RIVER, MICHIGAN 49878

WINDY CITY FIREWORKS INC.              CLASS "C" AND "B" FIREWORKS  
P.O. BOX 11                                  (GOOD PRICES!)  
ROCHESTER, INDIANA 46975

BOOKS  
AAAAA  
THE ANARCHIST'S COOKBOOK              (highly inaccurate)

THE IMPROVISED MUNITIONS MANUAL    (formulas work, but put maker at risk)

MILITARY EXPLOSIVES

Two manuals of interest: Duponts "Blaster's Handbook", a \$20 manual mainly useful for rock and seismographic operations. Atlas's "Powder Manual" or "Manual of Rock Blasting" (I forget the title, it's in the office). This is a

\$60 book, well worth the cash, dealing with the above two topics, plus demolitions, and non-quarry blasting.

## 9.0 CHECKLIST FOR RAIDS ON LABS

In the end, the serious terrorist would probably realize that if he/she wishes to make a truly useful explosive, he or she will have to steal the chemicals to make the explosive from a lab. A list of such chemicals in order of priority would probably resemble the following:

LIQUIDS	SOLIDS
_____	_____
___ Nitric Acid	___ Potassium Perchlorate
___ Sulfuric Acid	___ Potassium Chlorate
___ 95% Ethanol	___ Picric Acid (usually a powder)
___ Toluene	___ Ammonium Nitrate
___ Perchloric Acid	___ Powdered Magnesium
___ Hydrochloric Acid	___ Powdered Aluminum
	___ Potassium Permanganate
GASES	___ Sulfur (flowers of)
_____	___ Mercury
	___ Potassium Nitrate
___ Hydrogen	___ Potassium Hydroxide
___ Oxygen	___ Phosphorus
___ Chlorine	___ Sodium Azide
___ Carbon Dioxide	___ Lead Acetate
	___ Barium Nitrate

## 10.0 USEFUL PYROCHEMISTRY

In general, it is possible to make many chemicals from just a few basic ones. A list of useful chemical reactions is presented. It assumes knowledge of general chemistry; any individual who does not understand the following reactions would merely have to read the first five chapters of a high school chemistry book.

1. potassium perchlorate from perchloric acid and potassium hydroxide

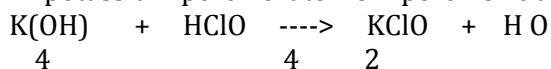

2. potassium nitrate from nitric acid and potassium hydroxide

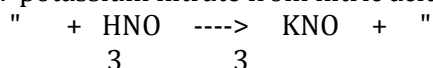

3. ammonium perchlorate from perchloric acid and ammonium hydroxide

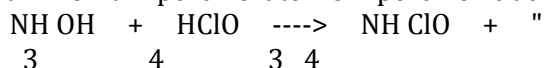

4. ammonium nitrate from nitric acid and ammonium hydroxide

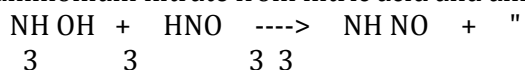

5. powdered aluminum from acids, aluminum foil, and magnesium

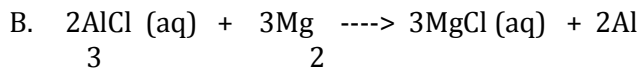
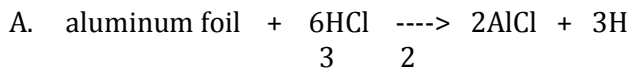

The Al will be a very fine silvery powder at the bottom of the container which must be filtered and dried. This same method works with nitric and sulfuric acids, but these acids are too valuable in the production of high explosives to use for such a purpose, unless they are available in great excess.

## 11.0 ABOUT THE EDITOR

The current editor is presently attending a small midwestern college. He has never been convicted, tried or charged with a crime, and will never admit to having committed any one of the 87 assorted misdemeanors and felonies (not counting multiple counts, such as the 103 dry ice bombs) which one might accuse him of. V.T. (The EDITOR)

## 11.1 ABOUT THE AUTHOR

While in high school, the original author became affiliated with CHAOS, and eventually became the head of Gunzenbomz Pyro-Technologies. At this time, at age 18, he produced his first high explosive device, putting a 1 foot deep crater in an associate's back yard. He had also produced many types of rockets, explosive ammunition, and other pyrotechnic devices.

While he was heading Gunzenbomz Pyro-Technologies, he was injured when a home made device exploded in his hand; he did not make the device. The author learned, however, and then decided to reform, and although he still constructs an occasional explosive device, he chooses to abstain from their production.

END OF PART 1 OF THE COMPLEAT TERRORIST

WARNING: The second part of this book consists of untested and quite possibly DANGEROUS plans, formulas and information. Under NO circumstances should the reader even consider attempting to carry out any of the procedures outlined below.

THE EDITOR (V.T.)

## PART 2 - Tennis ball cannons

----- Information from the Usenet. The Usenet is a worldwide network of 15,000 machines and over 500,000 people- And growing!

Addendum by The Editor: If you aren't in the Chicago area, check a local BBS list. If you see a BBS which runs under UNIX, odds are it carries usenet. The appropriate place to look is rec.pyrotechnics.

At this time (twelve years ago) most soft drink cans were rolled tin rather than the molded aluminum. We would cut the tops and bottoms off of a bunch of them and tape them together with duct tape, forming a tube of two feet or more.

At the end we would tape a can with the bottom intact, more holes punched (with a can opener) around the top, and a small hole in the side at the base. We then fastened this contraption to a tripod so we could aim it reliably. Any object that came somewhat close to filling the tube was then placed therein.

In the shop, we used the clock as a target and an empty plastic solder spool as ammunition, with tape over the ends of the center hole and sometimes filled with washers for weight. When taken to parties or picnics, we would use whatever was handy. Hot dog rolls or napkins filled with potato chips provided spectacular entertainment.

Once loaded, a small amount of lighter fluid was poured into the hole in the side of the end can and allowed to vaporize for a few moments. The "fire control technician" would announce "Fire in the Hole" and ignite it.

BOOM! Whoosh! The clock never worked after that!

-----

Our version of the potato chip cannon, originally designed around the Pringles potato chip can, was built similarly. Ours used coke cans, six with the top and bottom removed, and the seventh had Bottle opener holes all around one end, the top of this can was covered with a grid or piece of wire screening to keep the tennis ball from falling all the way to the bottom. This was spiral wrapped with at least two rolls of duct tape.

A wooden shoulder rest and forward hand grip was taped to the tube. For ignition we used lantern batteries to a model-t coil, actuated by a push button on the hand grip. A fresh wilson tennis ball was stuffed all the way back to the grid, and a drop or two of lighter fluid was dropped in one of two holes in the end. The ignition wire was poked through the other hole.

We would then lie in ambush, waiting for something to move. When fired with the proper air/fuel mixture, a satisfying thump! At maximum range the ball would travel about 100 yards with a 45 degree launch angle. Closer up the ball would leave a welt on an warring opponent. When launched at a moving car the thud as it hit the door would generally rattle anyone inside. Luckily we never completed the one that shot golf balls.

#### PART 4

##### More Fun Stuff for Terrorists

##### Carbide Bomb

This is EXTREMELY DANGEROUS. Exercise extreme caution.... Obtain some calcium carbide. This is the stuff that is used in carbide lamps and can be found at nearly any hardware store.

Take a few pieces of this stuff (it looks like gravel) and put it in a glass jar with some water. Put a lid on tightly. The carbide will react with

the water to produce acetylene carbonate which is similar to the gas used in cutting torches.

Eventually the glass will explode from internal pressure. If you leave a burning rag nearby, you will get a nice fireball!

#### Auto Exhaust Flame Thrower

For this one, all you need is a car, a sparkplug, ignition wire and a switch. Install the spark plug into the last four or five inches of the tailpipe by drilling a hole that the plug can screw into easily. Attach the wire (this is regular insulated wire) to one side of the switch and to the spark plug. The other side of the switch is attached to the positive terminal on the battery. With the car running, simply hit the switch and watch the flames fly!!! Again be careful that no one is behind you! I have seen some of these flames go 20 feet!!!

PART 5- This is all various files I gleaned from BBS's. (Added 8-23-90)

Balloons are fun to play with in chem lab, fill them with the gas that you get out of the taps on the lab desks, then tie up the balloon tight, and drop it out the window to the burnouts below, you know, the ones that are always smoking, they love to pop balloons with lit cigarette.... get the picture? Good...

#### OPENING COMBO LOCKS

[ Touched up by V.T - The Editor ]

First of all, let me tell you about the set-up of a lock. When the lock is locked, there is a curved piece of metal wedged inside the little notch on the horseshoe shaped bar (known as the shackle) that is pushed in to the lock when you lock it.

To free this wedge, you usually have to turn the lock to the desired combination and the pressure on the wedge is released therefore letting the lock open. I will now tell you how to make a pick so you can open a lock without having to waste all that time turning the combination (this also helps when you don't know the combination to begin with).

To bypass this hassle, simply take a thinned hairpin (file it down) or a opened out piece of a collapsing antenna (the inside diameter of the curved piece of metal should be the same as the diameter of the shackle- if the metal is too thick, use fine sandpaper to thin it down).

Once you have your hair pin (make sure it's metal), take the ridged side and break it off right before it starts to make a U-turn onto the straight side. The curved part can now be used as a handle. Now, using a file, file down the other end until it is fairly thin. You should do this to many hairpins and file them so they are of different thicknesses so you can jimmy various locks.

Look at a lock to see which side the lock opens from. If you can't tell, you will just have to try both sides. When you find out what side it opens from, take the lock pick and stick the filed end into the inside of the horseshoe-shaped bar on whichever side the lock opens from.

Now, put pressure on the handle of the lock pick (pushing down, into the crack) and pull the lock up and down. The lock will then open because the pick separated the wedge and the notch allowing it to open.

Also, this technique works best on American locks. I have never picked a Master lock before because of the shape a pressure of the wedge but if anyone does it, let me know how long it took. Also, the Master lock casing is very tight so ya can't get the shim in.

#### PYROTECHNICAL DELIGHTS WRITTEN BY RAGNER ROCKER

Many of you out there probably have fantasies of revenge against teachers, principals and other people who are justassholes. depending on your level of hatred of this person i would advise that you do some of these following experiments:

(1) Pouring dishsoap into the gas tank of your enemy- many of you already know that gasoline + dishsoap(e.g. joy, palmolive, etc.) form a mixture called napalm. now napalm is a jelly-like substance used in bombs, flamethrowers, etc. now you can only guess what this mixture would do to someone's fuel line!!!!

(2) Spreading dirty motor oil/castor oil on someone's exhaust pipe- when the exhaust pipe heats up(and it will!!)the motor oil or castor oil on the pipe will cause thick, disgusting smoke to ooze forth from the back of that car. Who knows maybe he/she might be pulled over and given a ticket!!

(3) Light Bulb Bomb- see part one of the file

(4) Simple smoke/stink bomb- you can purchase sulphur at a drugstore under the name flowers of sulphur. now when sulphur burns it will give off a very strong odor and plenty of smoke. now all you need is a fuse from a firecracker, a tin can, and the sulphur. fill the can with sulphur(pack very lightly), put aluminum foil over the top of the can, poke a small hole into the foil, insert the wick, and light it and get out of the room if you value your lungs. you can find many uses for this( or at least i hope so.

#### FUN WITH ALARMS

A fact I forgot to mention in my previous alarm articles is that one can also use polyurethane foam in a can to silence horns and bells. You can purchase this at any hardware store as insulation. it is easy to handle and dries faster.

Many people that travel carry a pocket alarm with them. this alarm is a small device that is hung around the door knob, and when someone touches the knob his body capacitance sets off the alarm. these nasty nuisances can be found by walking down the halls of a hotel and touching all the door knobs very quickly. if you happen to chance upon one, attach a 3' length of wire or other metal object to the knob. this will cause the sleeping business pig inside to think someone is breaking in and call room service for help. all sorts of fun and games will ensue.

Some high-security installations use keypads just like touch-tone pads (a registered trade mark of bell systems) to open locks or disarm alarms. most use three or four digits. to figure out the code, wipe the key-pad free from all fingerprints by using a rag soaked in rubbing alcohol. after the keypad has been used just apply finger print dust and all four digits will be marked. now all you have to do is figure out the order. if you want to have some fun with a keypad, try pressing the \* and # at the same time. many units use this as a panic button. This will bring the owner and the cops running and ever-one will have a good time. never try to remove these panels from the wall, as they have built-in tamper switches.

On the subject of holdups, most places (including supermarkets, liquor stores, etc.) have what is known as a money clip. these little nasties are placed at the bottom of a money drawer and when the last few bills are with-drawn a switch closes and sets the alarm off. that's why when you make your withdrawl it's best to help yourself so you can check for these little nasties. if you find them, merely insert ones underneath the pile of twenties, and then pull out the twenties, leaving the one-dollar bill behind to prevent the circuit from closing.

SOFT DRINK CAN BOMB AN ARTICLE FROM THE BOOK:

THE POOR MAN'S JAMES BOND BY KURT SAXON

This is an anti-personnel bomb meant for milling crowds. the bottom of a soft drink can is half cut out and bent back. a giant firecracker or other explosive is put in and surrounded with nuts and bolts or rocks. the fuse is then armed with a chemical delay in a plastic drinking straw.

```
!!           After first making sure there are no
!!           children nearby, the acid or glycerine
!! <-CHEMICAL INGITER   is put into the straw and the can is set
---- ----   down by a tree or wall where it will not
! !1! !       be knocked over. the delay should give
! ===== !   you three to five minutes. it will then
!* !!! " !    have a shattering effect on passersby.
! ! ! !
! ! ! !<- BIG FIRECRACKER
! ! ! % !
! ===== !
!   !
! # !         It is hardly likely that anyone would
! --- !       pick up and drink from someone else's
! ! ! <- NUTS & BOLTS  soft drink can. but if such a crude
! / !         person should try to drink from your
!   !         bomb he would break a nasty habit
-----      fast!
```

Pyro Book ][ by Capt Hack and Grey Wolf

TIME DELAYED CHEMICAL FUSE

- 1) Put 1 teaspoon full of potassium permanganate in a tin can.
- 2) add a few drops of glycerine
- 3) wait 3-4 min.
- 4) get the hell out.. the stuff will smoke, then burst into flame..

\*\* potassium permanganate stains like iodine but worse [it's purple]

\*\* the reaction will spatter a bit ->it can be messy...

\*\* it doesn't matter if the amounts are uneven [ie. 1 part to 3 parts]

## EXPLOSIVES AND INCENDIARIES by THE RESEARCHER

INTRODUCTION: The trouble with text books on chemistry and explosives is the attitude with which they are written. They don't say, "Now I know you would like to blow holy hell out of something just for the fun of it so here is how to whip up something in your kitchen to do it". They tell you how Dupont does it or how the ancient Chinese did it but not how you can do it with the resources and materials available to you.

Even army manuals on field expedient explosives are almost useless because they are just outlines written with the understanding that an instructor is going to fill in the blanks. It is a fun game to search out the materials that can be put together to make something go "boom". You can find what you need in grocery stores, hardware stores, and farm supplies. An interesting point to remember is that it is much easier to make a big explosion than a small one. It is very difficult for a home experimenter to make a firecracker, but a bomb capable of blowing the walls out of a building is easy.

### HOW TO MAKE ROCKET FUEL

This is easy to make and fun to play with. Mix equal parts by volume Potassium or Sodium Nitrate and granulated sugar. Pour a big spoonful of this into a pile. Stick a piece of blackmatch fuse into it; light; and step back. This is also a very hot incendiary. A little imagination will suggest a lot of experiments for this.

### ANOTHER ROCKET FUEL

Mix equal parts by volume of zinc dust and sulfur. Watch out if you experiment with this. It goes off in a sudden flash. It is not a powerful explosive, but is violent stuff even when not confined because of its fast burning rate.

--- As I continue from this point some of the ingredients are going to be harder to get without going through a chemical supply. I try to avoid this. I happen to know that B. Prieser Scientific (local to my area) has been instructed by the police to send them the names of anyone buying chemicals in certain combinations. For example, if a person were to buy Sulfuric acid, Nitric acid and Toluene (the makings for TNT) in one order the police would be notified. I will do the best I can to tell you how to make the things you need from commonly available materials, but I don't want to leave out something really good because you might have to scrounge for an ingredient. I am guessing you would prefer it that way.

## HOW TO MAKE AN EXPLOSIVE FROM COMMON MATCHES

Pinch the head near the bottom with a pair of wire cutters to break it up; then use the edges of the cutters to scrape off the loose material. It gets easy with practice. You can do this while watching TV and collect enough for a bomb without dying of boredom.

Once you have a good batch of it, you can load it into a pipe instead of black powder. Be careful not to get any in the threads, and wipe off any that gets on the end of the pipe. Never try to use this stuff for rocket fuel. A science teacher was killed that way.

Just for fun while I'm on the subject of matches, did you know that you can strike a safety match on a window pane? Hold a paper match between your thumb and first finger. With your second finger, press the head firmly against a large window. Very quickly, rub the match down the pane about 2 feet while maintaining the pressure. The friction will generate enough heat to light the match.

Another fun trick is the match rocket. Tightly wrap the top half of a paper match with foil. Set it in the top of a pop bottle at a 45 degree angle. Hold a lighted match under the head until it ignites. If you got it right, the match will zip up and hit the ceiling.

I just remembered the match guns I used to make when I was a kid. These are made from a bicycle spoke. At one end of the spoke is a piece that screws off. Take it off and screw it on backwards. You now have a piece of stiff wire with a small hollow tube on one end. Pack the material from a couple of wooden safety matches into the tube. Force the stem of a match into the hole. It should fit very tightly. Hold a lighted match under the tube until it gets hot enough to ignite the powder. It goes off with a bang.

## HOW TO MAKE CONCENTRATED SULFURIC ACID FROM BATTERY ACID

Go to an auto supply store and ask for "a small battery acid". This should only cost a few dollars. What you will get is about a gallon of dilute sulfuric acid. Put a pint of this into a heat resistant glass container. The glass pitchers used for making coffee are perfect. Do not use a metal container.

Use an extension cord to set up a hotplate out doors. Boil the acid until white fumes appear. As soon as you see the white fumes, turn off the hot plate and let the acid cool. Pour the now concentrated acid into a glass container. The container must have a glass stopper or plastic cap -- no metal. It must be air tight. Otherwise, the acid will quickly absorb moisture from the air and become diluted. Want to know how to make a time bomb that doesn't tick and has no wires or batteries? Hold on to your acid and follow me into the next installment.

## HOW TO MAKE A CHEMICAL TIME DELAY FUSE:

To get an understanding of how this is going to work, mix up equal parts by volume Potassium chlorate and granulated sugar. Pour a spoonful of the mixture in a small pile and make a depression in the top with the end of a

spoon. Using a medicine dropper, place one drop of concentrated sulfuric acid in the depression and step back.

It will snap and crackle a few times and then burst into vigorous flames. To make the fuse, cut about 2 inches off a plastic drinking straw. Tamp a small piece of cotton in one end. On top of this put about an inch of the chlorate/sugar mixture.

Now lightly tamp in about a quarter inch of either glass wool or asbestos fibers. Secure this with the open end up and drop in 3 or 4 drops of sulfuric acid. After a few minutes the acid will soak through the fibers and ignite the mixture.

The time delay can be controlled by the amount of fiber used and by varying how tightly it is packed. Don't use cotton for this. The acid will react with cotton and become weakened in the process. By punching a hole in the side of the straw, a piece of blackmatch or other fuse can be inserted and used to set off the device of your choice.

Potassium chlorate was very popular with the radical underground. It can be used to make a wide variety of explosives and incendiaries, some of them extremely dangerous to handle. The radicals lost several people that way. But, don't worry. I am not going to try to protect you from yourself. I have decided to tell all. I will have more to say about Potassium chlorate, but for now, let's look at a couple of interesting electric fuses.

#### PEROXYACETONE

PEROXYACETONE IS EXTREMELY FLAMMABLE AND HAS BEEN REPORTED TO BE SHOCK SENSITIVE.

#### MATERIALS-

4ML ACETONE

4ML 30% HYDROGEN PEROXIDE

4 DROPS CONC. HYDROCHLORIC ACID

150MM TEST TUBE

Add 4ml acetone and 4ml hydrogen peroxide to the test tube. then add 4 drops concentrated hydrochloric acid. In 10-20 minutes a white solid should begin to appear. if no change is observed, warm the test tube in a water bath at 40 celsius. Allow the reaction to continue for two hours. Swirl the slurry and filter it. Leave out on filter paper to dry for at least two hours. To ignite, light a candle tied to a meter stick and light it (while staying at least a meter away).

I would like to give credit to a book by shakashari entitled "Chemical demonstrations" for a few of the precise amounts of chemicals in some experiments.

...ZAPHOD BEEBLEBROX/MPG!

#### THE CHEMIST'S CORNER #2: HOUSEHOLD CHEMICALS, BY ZAPHOD BEEBLEBROX/MPG

This article deals with instructions on how to do some interesting experiments with common household chemicals. Some may or may not work

depending on the concentration of certain chemicals in different areas and brands. I would suggest that the person doing these experiments have some knowledge of chemistry, especially for the more dangerous experiments.

I am not responsible for any injury or damage caused by people using this information. It is provided for use by people knowledgeable in chemistry who are interested in such experiments and can safely handle such experiments.

#### I. A LIST OF HOUSEHOLD CHEMICALS AND THEIR COMPOSITION

VINEGAR: 3-5% ACETIC ACID      BAKING SODA: SODIUM BICARBONATE  
DRAIN CLEANERS: SODIUM HYDROXIDE      SANI-FLUSH: 75% SODIUM BISULFATE  
AMMONIA WATER: AMMONIUM HYDROXIDE      CITRUS FRUIT: CITRIC ACID  
TABLE SALT: SODIUM CHLORIDE      SUGAR: SUCROSE  
MILK OF MAGNESIA-MAGNESIUM HYDROXIDE      TINCTURE OF IODINE- 4% IODINE  
RUBBING ALCOHOL- 70 OR 99% (DEPENDS ON BRAND) ISOPROPYL ALCOHOL (DO NOT DRINK!)

#### GENERATING CHLORINE GAS

This is slightly more dangerous than the other two experiments, so you should know what you're doing before you try this...

Ever wonder why ammonia bottles always say 'do not mix with chlorine bleach', and visa-versa? That's because if you mix ammonia water with ajax or something like it, it will give off chlorine gas. To capture it, get a large bottle and put ajax in the bottom. then pour some ammonia down into the bottle. since the chlorine is heavier than air, it will stay down in there unless you use large amounts of either ajax or ammonia (don't!).

#### CHLORINE + TURPENTINE

Take a small cloth or rag and soak it in turpentine. Quickly drop it into the bottle of chlorine. It should give off a lot of black smoke and probably start burning...

#### GENERATING HYDROGEN GAS

To generate hydrogen, all you need is an acid and a metal that will react with that acid. Try vinegar (acetic acid) with zinc, aluminum, magnesium, etc. You can collect hydrogen in something if you note that it is lighter than air.... light a small amount and it burns with a small \*pop\*.

Another way of creating hydrogen is by the electrolysis of water. this involve sseperating water (H<sub>2</sub>O) into hydrogen and oxygen by an electric current. To do this, you need a 6-12 volt battery (or a DC transformer), two test tubes, a large bowl, two carbon electrodes (take them out of an unworking 6-12 volt battery), and table salt. Dissolve the salt in a large bowl full of water. Submerge the two test tubes in the water and put the electrodes inside them, with the mouth of the tube aiming down. Connect the battery to some wire going down to the electrodes.

This will work for a while, but chlorine will be generated along with the oxygen which will corrode your copper wires leading to the carbon electrodes... (the table salt is broken up into chlorine and sodium ions, the chlorine comes off as a gas with oxygen while sodium reacts with the water to form sodium hydroxide....). therefore, if you can get your hands on some sulfuric acid, use it instead. it will not affect the reaction other than making the water conduct electricity.

WARNING: DO NOT use a transformer that outputs AC current! Not only is AC inherently more dangerous than DC, it also produces both Hydrogen and Oxygen at each electrode.

#### HYRDOGEN + CHLORINE

Take the test tube of hydrogen and cover the mouth with your thumb. Keep it inverted, and bring it near the bottle of chlorine (not one that has reacted with turpentine). Say "goodbye test tube", and drop it into the bottle. The hydrogen and chlorine should react and possibly explode (depending on purity and amount of each gas). An interesting thing about this is they will not react if it is dark and no heat or other energy is around. When a light is turned on, enough energy is present to cause them to react...

#### PREPARATION OF OXYGEN

Get some hydrogen peroxide (from a drug store) and manganese dioxide (from a battery- it's a black powder). Mix the two in a bottle, and they give off oxygen. If the bottle is stoppered, pressure will build up and shoot it off.

Try lighting a wood splint and sticking it (when only glowing) into the bottle. The oxygen will make it burst into flame. The oxygen will allow things to burn better...

#### IODINE

Tincture of iodine contains mainly alcohol and a little iodine. To separate them, put the tincture of iodine in a metal lid to a bottle and heat it over a candle. Have a stand holding another metal lid directly over the tincture (about 4-6 inches above it) with ice on top of it. The alcohol should evaporate, and the iodine should sublime, but should reform iodine crystals on the cold metal lid directly above. If this works (I haven't tried), you can use the iodine along with household ammonia to form nitrogen triiodide.

...ZAPHOD BEEBLEBROX/MPG!

I have found that Pool Chlorine tablets with strong household ammonia react to produce LOTS of chlorine gas and heat... also mixing the tablets with rubbing alcohol produces heat, a different (and highly flammable) gas, and possibly some sort of acid (it eats away at just about anything it touches)

David Richards

#### TRIPWIRES

by The Mortician

Well first of all I recommend that you read the file on my board about landmines... If you can't then here is the concept.

You can use an m-80,h-100, blockbuster or any other type of explosive that will light with a fuse. Now the way this works is if you have a 9 volt battery, get either a solar igniter (preferably) or some steel wool you can create a remote ignition system. What you do it set up a schematic like this.

```
----->+ batery
steel ||    ->- batery
wool ||     /
:==:--- <--fuse  \
||           /
---- spst switch--\
```

So when the switch is on the current will flow through the steel wool or igniter and heat up causing the fuse to light.

Note: For use with steel wool try it first and get a really thin piece of wire and pump the current through it to make sure it will heat up to light the explosive.

Now the thing to do is plant your explosive wherever you want it to be, bury it and cover the wires. Now take a fishing line (about 20 lb. test) and tie one end to a secure object. Have your switch secured to something and make a loop on the other end on the line. Put the loop around the switch such that when pulled it will pull the switch and set off the explosive.

To ignite the explosive... The thing to do is to experiment with this and find your best method... Let me know on any good kills, or new techniques... On my board... (201)376-4462

BOOBY TRAP TRIP WIRES..... BY Vlad Tepes (of Chgo C64 fame)

Here is a method for constructing boobytraps which I personally invented, and which I have found to work better than any other type of release booby trap.

There are many possible variations on this design, but the basic premise remains the same. What you'll need:

- 3-4 nails each 2 inches long and soft enough to bend easily (galvanized iron works well)
- 6 feet of wire or fishing line
- 5-15 feet of strong string or rope
- 1 really sick mind.

Hammer two of the nails into the trunk of a tree (about one inch apart) so they form a horizontal line. They should be angled slightly upward, about 30 degrees.

Bend each nail Downward about one inch out from the trunk. Take your

nefarious device (say a small rock suspended in a tree) and rig a rope or string so the line comes DOWN towards the two nails. Tie a loop in the string so the loop \*just\* reaches between the two nails, and pass a third nail between the two nails with the loop around this nail between the two others (see diagrams)

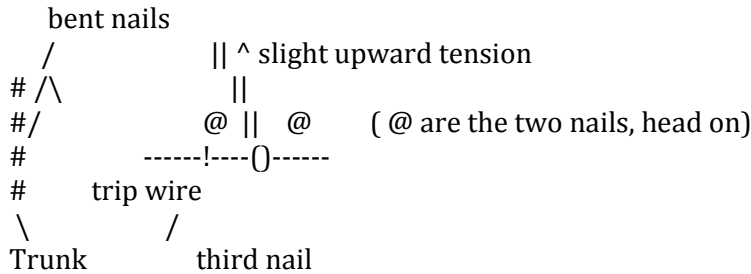

Now tie one end of the fishing line to the head of the third nail, and the other end around another tree or to a nail (in another tree, a root or a stump etc).

When somebody pulls on the trip wire, the nail will be pulled out and your sick creation will be released to do it's damage (try tying it to a firing pin).

There are several possible variations. More than one trip wire can be attached to the same nail, or this device can be used to arm a second trip wire. Large wire staples or hook and eye loops can be used to replace the two bent nails.

A more interesting variation uses a straight piece of metal rod with a hole at each end, or with a short wire loop welded to each end. One end is attached to the tripwire, the other is attached to a spring.

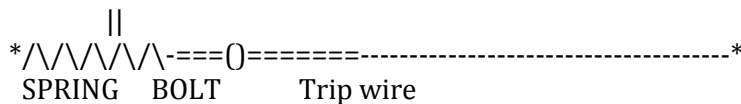

With this design the loop will be released if the tripwire is pulled or if it is broken. The spring should be under moderate tension and well oiled.

### Improvised Explosives

Gelatine Explosive from Anti-Freeze      Written by: The Lich

**CAUTION: THIS FORMULA ASSUMES THAT THE MAKER HAS NO QUALMS ABOUT KILLING HIS/HER SELF IN THE PROCESS.**

This explosive is almost the same as the nitro-gelatin plastique explosive except that it is supple and pliable to -10 to -20 deg. C

Antifreeze is easier to obtain than glycerine and is usually cheaper. It needs to be freed of water before the manufacture and this can be done by treating it with calcium chloride until a specific gravity of 1.12 @ 0 deg. C. or 1.11 @ 20 deg. C. is obtained.

This can be done by adding calcium chloride to the antifreeze and checking with a hydrometer and continue to add calcium chloride until the proper reading is obtained. The antifreeze is then filtered to remove the calcium chloride from the liquid. This explosive is superior to nitro-gelatin in that it is easier to collidon the IMR smokeless powder into the explosive and that the 50/50 ether ethyl alcohol can be done away with. It is superior in that the formation of the collidon is done very rapidly by the nitroethelene glycol.

It's detonation properties are practically the same as the nitro-gelatine. Like the nitro-gelatine it is highly flammable and if caught on fire the chances are good that the flame will progress to detonation. In this explosive as in nitro-gelatine the addition of 1% sodium carbonate is a good idea to reduce the chance of recidual acid being present in the final explosive. The following is a slightly different formula than nitro-gelatine:

Nitro-glycol 75% Guncotton (IMR) 6% Potassium Nitrate 14% Flour 5%

In this process the 50/50 step is omitted. Mix the potassium nitrate with the nitro-glycol. Remember that this nitro-glycol is just as sensitive to shock as is nitroglycerin.

The next step is to mix in the baking flour and sodium carbonate. Mix these by kneading with gloved hands until the mixture is uniform. This kneading should be done gently and slowly. The mixture should be uniform when the IMR smokeless powder is added. Again this is kneaded to uniformity. Use this explosive as soon as possible.

If it must be stored, store in a cool, dry place (0-10 deg. C.). This explosive should detonate at 7600-7800 m/sec.. These two explosives are very powerful and should be sensitive to a #6 blasting cap or equivalent.

These explosives are dangerous and should not be made unless the manufacturer has had experience with this type compound. The foolish and ignorant may as well forget these explosives as they won't live to get to use them.

Don't get me wrong, these explosives have been manufactured for years with an amazing record of safety. Millions of tons of nitroglycerine have been made and used to manufacture dynamite and explosives of this nature with very few mis haps.

Nitroglycerin and nitroglycol will kill and their main victims are the stupid and foolhardy. Before manufacturing these explosives take a drop of nitroglycerin and soak into a small piece of filter paper and place it on an anvil.

Hit this drop with a hammer and don't put any more on the anvil. See what I mean! This explosive compound is not to be taken lightly. If there are any doubts DON'T.

Improvised Explosives Plastique Explosive from Aspirin by: The Lich

This explosive is a phenol derivative. It is HIGHLY toxic and explosive compounds made from picric acid are poisonous if inhaled, ingested, or handled and absor- bed through the skin. The toxicity of this explosive restrict's its use due to the fact that over exposure in most cases causes liver and

kidney failure and sometimes death if immediate treatment is not obtained.

This explosive is a cousin to T.N.T. but is more powerful than its cousin. It is the first explosive used militarily and was adopted in 1888 as an artillery shell filler. Originally this explosive was derived from coal tar but thanks to modern chemistry you can make this explosive easily in approximately three hours from acetylsalicylic acid (aspirin purified).

This procedure involves dissolving the acetylsalicylic acid in warm sulfuric acid and adding sodium or potassium nitrate which nitrates the purified aspirin and the whole mixture drowned in water and filtered to obtain the final product. This explosive is called trinitrophenol. Care should be taken to ensure that this explosive is stored in glass containers. Picric acid will form dangerous salts when allowed to contact all metals except tin and aluminum. These salts are primary explosive and are super sensitive. They also will cause the detonation of the picric acid.

To make picric acid obtain some aspirin. The cheaper brands work best but buffered brands should be avoided. Powder these tablets to a fine consistency. To extract the acetylsalicylic acid from this powder place this powder in methyl alcohol and stir vigorously. Not all of the powder will dissolve. Filter this powder out of the alcohol. Again wash this powder that was filtered out of the alcohol with more alcohol but with a lesser amount than the first extraction. Again filter the remaining powder out of the alcohol. Combine the now clear alcohol and allow it to evaporate in a pyrex dish. When the alcohol has evaporated there will be a surprising amount of crystals in the bottom of the pyrex dish.

Take forty grams of these purified acetylsalicylic acid crystals and dissolve them in 150 ml. of sulfuric acid (98%, specific gravity 1.8) and heat to dissolve all the crystals. This heating can be done in a common electric frying pan with the thermostat set on 150 deg. F. and filled with a good cooking oil.

When all the crystals have dissolved in the sulfuric acid take the beaker, that you've done all this dissolving in (600 ml.), out of the oil bath. This next step will need to be done with a very good ventilation system (it is a good idea to do any chemistry work such as the whole procedure and any procedure on this disk with good ventilation or outside). Slowly start adding 58 g. of sodium nitrate or 77 g. of potassium nitrate to the acid mixture in the beaker very slowly in small portions with vigorous stirring. A red gas (nitrogen trioxide) will be formed and this should be avoided.

The mixture is likely to foam up and the addition should be stopped until the foaming goes down to prevent the overflow of the acid mixture in the beaker. When the sodium or potassium nitrate has been added the mixture is allowed to cool somewhat (30- 40 deg. C.). The solution should then be dumped slowly into twice its volume of crushed ice and water. The brilliant yellow crystals will form in the water. These should be filtered out and placed in 200 ml. of boiling distilled water. This water is allowed to cool and then the crystals are then filtered out of the water. These crystals are a very, very pure trinitrophenol. These crystals are then placed in a pyrex dish and placed in an oil bath and heated to 80 deg. C. and held there for 2 hours. This temperature is best maintained and checked with a thermometer.

The crystals are then powdered in small quantities to a fine powder consistency. These powdered crystals are then mixed with 10% by weight wax and 5% vaseline which are heated to melting temperature and poured into the crystals. The mixing is best done by kneading together with gloved hands. This explosive should have a useful plasticity range of 0-40 deg. C.. The detonation velocity should be around 7000 m/sec.. It is toxic to handle but simply made from common ingredients and is suitable for most demolition work requiring a moderately high detonation velocity. It is very suitable for shaped charges and some steel cutting charges. It is not as good an explosive as C-4 or other R.D.X. based explosives but it is much easier to make. Again this explosive is very toxic and should be treated with great care.

AVOID HANDLING BARE-HANDED, BREATHING DUST AND FUMES, AVOID ANY CHANCE OF INGESTION. AFTER UTENSILS ARE USED FOR THE MANUFACTURE OF THIS EXPLOSIVE RETIRE THEM FROM THE KITCHEN AS THE CHANCE OF POISONING IS NOT WORTH THE RISK. THIS EXPLOSIVE, IF MANUFACTURED AS ABOVE, SHOULD BE SAFE IN STORAGE BUT WITH ANY HOMEMADE EXPLOSIVE STORAGE IS NOT RECOMMENDED AND EXPLOSIVES SHOULD BE MADE UP AS NEEDED.

#### Improvised Explosives Plastic Explosive from Bleach by: The Lich

This explosive is a potassium chlorate explosive. This explosive and explosives of similar composition were used in World War II as the main explosive filler in grenades, land mines, and mortar used by French, German, and other forces involved in that conflict. These explosives are relatively safe to manufacture.

One should strive to make sure these explosives are free of sulfur, sulfides, and picric acid. The presence of these compounds result in mixtures that are or can become highly sensitive and possibly decompose explosively while in storage. The manufacture of this explosive from bleach is given as just an expedient method. This method of manufacturing potassium chlorate is not economical due to the amount of energy used to boil the solution and cause the 'dissociation' reaction to take place. This procedure does work and yields a relatively pure and a sulfur/sulfide free product. These explosives are very cap sensitive and require only a #3 cap for instigating detonation.

To manufacture potassium chlorate from bleach (5.25% sodium hypochlorite solution) obtain a heat source (hot plate etc.) a battery hydrometer, a large pyrex or enameled steel container (to weigh chemicals), and some potassium chloride (sold as salt substitute). Take one gallon of bleach, place it in the container and begin heating it. While this solution heats, weigh out 63 g. potassium chloride and add this to the bleach being heated. Bring this solution to a boil and boiled until when checked by a hydrometer the reading is 1.3 (if a battery hydrometer is used it should read full charge).

When the reading is 1.3 take the solution and let it cool in the refrigerator until it's between room temperature and 0 deg. C.. Filter out the crystals

that have formed and save them. Boil the solution again until it reads 1.3 on the hydrometer and again cool the solution. Filter out the crystals that have formed and save them. Boil this solution again and cool as before.

Filter and save the crystals. Take these crystals that have been saved and mix them with distilled water in the following proportions: 56 g. per 100 ml. distilled water. Heat this solution until it boils and allow it to cool. Filter the solution and save the crystals that form upon cooling. The process of purification is called fractional crystallization. These crystals should be relatively pure potassium chlorate.

Powder these to the consistency of face powder (400 mesh) and heat gently to drive off all moisture. Melt five parts vasoline and five parts wax. Dissolve this in white gasoline (camp stove gasoline) and pour this liquid on 90 parts potassium chlorate (the crystals from the above operation) in a plastic bowl. Knead this liquid into the potassium chlorate until immediately mixed. Allow all the gasoline to evaporate. Place this explosive in a cool, dry place. Avoid friction, sulfur, sulfide, and phosphorous compounds.

This explosive is best molded to the desired shape and density (1.3g./cc.) and dipped in wax to water proof. These block type charges guarantee the highest detonation velocity. This explosive is really not suited to use in shaped charge applications due to its relatively low detonation velocity. It is comparable to 40% ammonia dynamite and can be considered the same for the sake of charge computation.

If the potassium chlorate is bought and not made it is put into the manufacture process in the powdering stages preceding the addition of the wax/vaseline mixture. This explosive is brisant and powerful. The addition of 2-3% aluminum powder increases its blast effect. Detonation velocity is 3300 m/sec..

#### Plastique Explosives From Swimming Pool Chlorinating Compound By the Lich

This explosive is a chlorate explosive from bleach. This method of production of potassium or sodium chlorate is easier and yields a more pure product than does the plastique explosive from bleach process.

In this reaction the H.T.H. (calcium hypochlorite  $\text{CaCl}_2 \cdot 2\text{H}_2\text{O}$ ) is mixed with water and heated with either sodium chloride (table salt, rock salt) or potassium chloride (salt substitute). The latter of these salts is the salt of choice due to the easy crystallization of the potassium chlorate.

This mixture will need to be boiled to ensure complete reaction of the ingredients. Obtain some H.T.H. swimming pool chlorination compound or equivalent (usually 65% calcium hypochlorite). As with the bleach process mentioned earlier the reaction described below is also a dissociation reaction. In a large pyrex glass or enameled steel container place 1200g. H.T.H. and 220g. potassium chloride or 159g. sodium chloride. Add enough boiling water to dissolve the powder and boil this solution. A chalky substance (calcium chloride) will be formed. When the formation of this chalky substance is no longer formed the solution is filtered while boiling hot. If potassium chloride was used potassium chlorate will be formed.

This potassium chlorate will drop out or crystalize as the clear liquid left after filtering cools. These crystals are filtered out when the solution reaches room temperature. If the sodium chloride salt was used this clear filtrate (clear liquid after filter- ation) will need to have all water evaporated. This will leave crystals which should be saved.

These crystals should be heated in a slightly warm oven in a pyrex dish to drive off all traces of water (40-75 deg. C.). These crystals are ground to a very fine powder (400 mesh).

If the sodium chloride salt is used in the initial step the crystalization is much more time consuming. The potassium chloride is the salt to use as the resulting product will crystalize out of the solution as it cools. The powdered and completely dry chlorate crystals are kneaded together with vaseline in a plastic bowl. ALL CHLORATE BASED EXPLOSIVES ARE SENSITIVE TO FRICTION AND SHOCK AND THESE SHOULD BE AVOIDED. If sodium chloride is used in this explosive it will have a tendency to cake and has a slightly lower detonation velocity.

This explosive is composed of the following:

potassium/sodium chlorate 90%    vaseline 10%

Simply pour the powder into a plastic baggy and knead in the vaseline carefully. this explosive (especially if the Sodium Chlorate variation is used) should not be exposed to water or moisture.

The detonation velocity can be raised to a slight extent by the addition of 2-3% aluminum substituted for 2-3% of the vaseline. This addition of this aluminum will give the explosive a bright flash if set off at night which will ruin night vision for a short while. The detonation velocity of this explosive is approximately 3200 m/sec. for the potassium salt and 2900 m/sec. for the sodium salt based explosive.

Addendum 4/12/91:

It was claimed above that this explosive degrades over time. I would assume that this occurs due to the small amount of water present in the vaseline, and that a different type of fuel would be better than the vaseline.

ASSORTED NASTIES:

#### Sweet-Oil

In this one you open there hood and pour some honey in their oil spout. if you have time you might remover the oil plug first and drain some of the oil out. I have tried this one but wasn't around to see the effects but I am sure that I did some damage.

#### Slow Air

Ok, sneak up the victims car and poke a small hole somewhere in 2 of his/her tires. They only have 1 spare. Now if the hole is small but there then there tire will go flat some where on the road. You could slice the tire so this is

blows out on the road with a razor blade. Cut a long and fairly deep (don't cut a hole all the way through) and peel a little bit of the rubber back and cut that off. Now very soon their tires will go flat or a possible blow out at a high speed if you're lucky.

#### Vanishing Paint

Spread a little gas or paint thinner on the victim's car and this will make his paint run and fade. Vodka will eat the paint off and so will a little 190. Eggs work great on paint if they sit there long enough.

#### Loose Wheel

Loosen the lug nuts on your victim's tires so that they will soon fall off. This can really fuck someone up if they are cruising when the tire falls off.

#### Dual Neutral

This name sucks but pull the 10 bolt or whatever they have there off. (On the real wheels, in the middle of the axle) Now throw some screws, bolts, nuts and assorted things in there and replace the cover. At this point you could chip some of the teeth off the gears.

#### Un-Midaser

Crawl under their car with a ratchet and loosen all the nuts on their exhaust so that it hangs low and will fall off soon. This method also works on transmissions but is a little harder to get all bolts off, but the harder you work the more you fuck them over.

### LAUGHING GAS

Learn how to make laughing gas from ammonium nitrate. Laughing gas was one of the earliest anaesthetics. After a little while of inhaling the gas the patient became so happy [ain't life great?] he couldn't keep from laughing. Finally he would drift off to a pleasant sleep.

Some do-it-yourselfers have died while taking laughing gas. This is because they have generated it through plastic bags while their heads were inside. They were simply suffocating but were too bombed out to realize it.

The trick is to have a plastic clothes bag in which you generate a lot of the gas. Then you stop generating the gas and hold a small opening of the bag under your nose, getting plenty of oxygen in the meantime. Then, Whee!

To make it you start with ammonium nitrate bought from a chemical supply house or which you have purified with 100% rubbing or wood alcohol.

First, dissolve a quantity of ammonium nitrate in some water. Then you evaporate the water over the stove, while stirring, until you have a heavy brine. When nearly all the moisture is out it should solidify instantly when a drop is put on an ice cold metal plate.

When ready, dump it all out on a very cold surface. After a while, break it up and store it in a bottle.

A spoonful is put into a flask with a one-hole stopper, with a tube leading into a big plastic bag. The flask is heated with an alcohol lamp.

When the temperature in the flask reaches 480 F the gas will generate. If white fumes appear the heat should be lowered as the stuff explodes at 600 F.

When the bag is filled, stop the action and get ready to turn on.

CAUTION: N2O supplants oxygen in your blood, but you don't realize it. It's easy to die from N2O because you're suffocating and your breathing reflex doesn't know it. Do not put your head in a plastic bag (duhh...) because you will cheerfully choke to death.

### PIPE OR "ZIP" GUNS

Commonly known as "zip" guns, guns made from pipe have been used for years by juvenile punks. Today's Militants make them just for the hell of it or to shoot once in an assassination or riot and throw away if there is any danger of apprehension.

They can be used many times but with some, a length of dowel is needed to force out the spent shell.

There are many variations but the illustration shows the basic design.

First, a wooden stock is made and a groove is cut for the barrel to rest in. The barrel is then taped securely to the stock with a good, strong tape.

The trigger is made from galvanized tin. A slot is punched in the trigger flap to hold a roofing nail, which is wired or soldered onto the flap. The trigger is bent and nailed to the stock on both sides.

The pipe is a short length of one-quarter inch steel gas or water pipe with a bore that fits in a cartridge, yet keeps the cartridge rim from passing through the pipe.

The cartridge is put in the pipe and the cap, with a hole bored through it, is screwed on. Then the trigger is slowly released to let the nail pass through the hole and rest on the primer.

To fire, the trigger is pulled back with the left hand and held back with the thumb of the right hand. The gun is then aimed and the thumb releases the trigger and the thing actually fires.

Pipes of different lengths and diameters are found in any hardware store. All caliber bullets, from the .22 to the .45 are used in such guns.

Some zip guns are made from two or three pipes nested within each other. For instance, a .22 shell will fit snugly into a length of a car's copper gas line. Unfortunately, the copper is too weak to withstand the pressure of the firing. So the length of gas line is spread with glue and pushed into a wider length of pipe. This is spread with glue and pushed into a length of steel pipe with threads and a cap.

Using this method, you can accommodate any cartridge, even a rifle shell. The first size of pipe for a rifle shell accommodates the bullet. The second

accommodates its wider powder chamber.

A 12-gauge shotgun can be made from a 3/4 inch steel pipe. If you want to comply with the gun laws, the barrel should be at least eighteen inches long.

Its firing mechanism is the same as that for the pistol. It naturally has a longer stock and its handle is lengthened into a rifle butt. Also, a small nail is driven half way into each side of the stock about four inches in the front of the trigger. The rubber band is put over one nail and brought around the trigger and snagged over the other nail.

In case you actually make a zip gun, you should test it before firing it by hand. This is done by first tying the gun to a tree or post, pointed to where it will do no damage. Then a string is tied to the trigger and you go off several yards. The string is then pulled back and let go. If the barrel does not blow up, the gun is (probably) safe to fire by hand. Repeat firings may weaken the barrel, so NO zip gun can be considered "safe" to use.

Astrolite and Sodium Chlorate Explosives By: Future Spy & The Fighting Falcon

Note: Information on the Astrolite Explosives were taken from the book 'Two Component High Explosive Mixtures' By Desert Pub'l

Some of the chemicals used are somewhat toxic, but who gives a fuck! Go ahead! I won't even bother mentioning 'This information is for enlightening purposes only!' I would love it if everyone made a gallon of astrolite and blew their fucking school to kingdom scum!

#### Astrolite

The astrolite family of liquid explosives were products of rocket propellant research in the '60's. Astrolite A-1-5 is supposed to be the world's most powerful non-nuclear explosive -at about 1.8 to 2 times more powerful than TNT. Being more powerful it is also safer to handle than TNT (not that it isn't safe in the first place) and Nitroglycerin.

#### Astrolite G

"Astrolite G is a clear liquid explosive especially designed to produce very high detonation velocity, 8,600MPS (meters/sec.), compared with 7,700MPS for nitroglycerin and 6,900MPS for TNT...In addition, a very unusual characteristic is that the liquid explosive has the ability to be absorbed easily into the ground while remaining detonatable...In field tests, Astrolite G has remained detonatable for 4 days in the ground, even when the soil was soaked due to rainy weather" know what that means?...Astrolite Dynamite!

To make (mix in fairly large container & outside)

Two parts by weight of ammonium nitrate mixed with one part by weight 'anhydrous' hydrazine, produces Astrolite G...Simple enough eh? I'm sure that the 2:1 ratio is not perfect, and that if you screw around with it long enough, that you'll find a better formula. Also, dunno why the book says 'anhydrous' hydrazine, hydrazine is already anhydrous...

Hydrazine is the chemical you'll probably have the hardest time getting

hold of. Uses for Hydrazine are: Rocket fuel, agricultural chemicals (maleic hydra-zide), drugs (antibacterial and antihypertension), polymerization catalyst, plating metals on glass and plastics, solder fluxes, photographic developers, diving equipment. Hydrazine is also the chemical you should be careful with.

#### Astrolite A/A-1-5

Mix 20% (weight) aluminum powder to the ammonium nitrate, and then mix with hydrazine. The aluminum powder should be 100 mesh or finer. Astrolite A has a detonation velocity of 7,800MPS.

#### Misc. info

You should be careful not to get any of the astrolite on you, if it happens though, you should flush the area with water. Astrolite A&G both should be able to be detonated by a #8 blasting cap.

#### Sodium Chlorate Formulas

Sodium Chlorate is similar to potassium chlorate, and in most cases can be a substitute. Sodium chlorate is also more soluble in water. You can find sodium chlorate at Channel or any hardware/home improvement store. It is used in blowtorches and you can get about 3lbs for about \$6.00.

#### Sodium Chlorate Gunpowder

65% sodium chlorate, 22% charcoal, 13% sulfur, sprinkle some graphite on top.

#### Rocket Fuel

6 parts sodium chlorate mixed \*THOROUGHLY\* with 5 parts rubber cement.

#### Rocket Fuel 2 (better performance)

50% sodium chlorate, 35% rubber cement ('One-Coat' brand), 10% epoxy resin hardener, 5% sulfur

You may want to add more sodium chlorate depending on the purity you are using.

#### Incendiary Mixture

55% aluminum powder (atomized), 45% sodium chlorate, 5% sulfur

#### Impact Mixture

50% red phosphorus, 50% sodium chlorate

Unlike potassium chlorate, sodium chlorate won't explode spontaneously when mixed with phosphorus. It has to be hit to be detonated.

#### Filler explosive

85% sodium chlorate, 10% vaseline, 5% aluminum powder

#### Nitromethane formulas

I thought that I might add this in since it's similar to Astrolite.

Nitromethane (CH<sub>3</sub>NO<sub>2</sub>)      specific gravity:1.139

flash point:95f                      auto-ignite:785f

Derivation: reaction of methane or propane with nitric acid under pressure.

Uses: Rocket fuel; solvent for cellulosic compounds, polymers, waxes, fats, etc.

To be detonated with a #8 cap, add:

1) 95% nitromethane + 5% ethylenediamine 2) 94% nitromethane + 6% aniline

Power output: 22-24% more powerful than TNT. Detonation velocity of 6,200MPS.

Nitromethane 'solid' explosives

2 parts nitromethane, 5 parts ammonium nitrate (solid powder)

soak for 3-5 min. when done,store in an air-tight container. This is supposed to be 30% more powerful than dynamite containing 60% nitro-glycerin, and has 30% more brilliance.

The Firey Explosive Pen    Written by Blue Max of Anarchist-R-Us

Materials Needed

Here's a GREAT little trick to play on

1] One Ball Point `Click` pen                      your best fiend (no thats not a typo) at

2] Gun Powder    skool, or maybe as a practical joke on a

3] 8 or 10 match heads                                      friend!

4] 1 Match stick

5] a sheet of sand paper (1 1/2" X 2")

1] Unscrew pen and remove all parts but leave the button in the top.

2] Stick the match stick in the part of the pen clicker where the other little parts and the ink fill was.

3] Roll sand paper up and put around the match stick that is in the clicker.

4] Put the remaining Match Heads inside the pen, make sure that they are on the inside on the sand paper.

5] Put a small piece of paper or something in the other end of the pen where the ball point comes out.

6] Fill the end with the piece of paper in it with gun powder. The paper is to keep the powder from spilling.

The Finished pen should look like this:

Small Paper Clog    Gun Powder    Matches & Sandpaper \

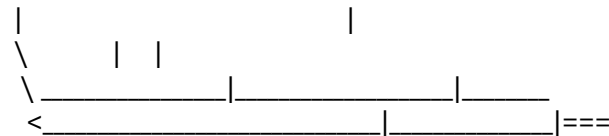

call the RIPCO bulletin board, 'a hell of a bbs' at (312) 528-5020

MERCURY BATTERY BOMB!    By Phucked Agent!

Materials:

1 Mercury Battery (1.5 or 1.4 V Hearing Aid), 1 working lamp with on/off switch

It is VERY SIMPLE!!! Hurray! Kids under 18 shouldn't considered try this one or else they would have mercuric acid on their faces!

1. Turn the lamp switch on to see if lite-bulb light up.
2. If work, leave the switch on and unplug the cord
3. Unscrew the bulb (Dont touch the hot-spot!)
4. Place 1 Mercury Battery in the socket and make sure that it is touching the Hot-spot contact.
5. Move any object or furniture - Why? There may be sparx given off!
6. Now your favorite part, stand back and plug in cord in the socket.
7. And you will have fun!! Like Real Party!!!